



HAILO **EINBAU**TECHNIK

ABFALLTRENN- UND ORDNUNGSSYSTEME FÜR DIE KÜCHE

ORGANIZER- AND WASTE-SEPARATION-SYSTEMS FOR THE KITCHEN



Passion
Leidenschaft
Faszination
Fascination

Hailo – Die Marke steht für Qualität.

Eine Küche muss perfekt ausgestattet sein, wenn man Freude beim Kochen oder bei den anderen Arbeiten in der Küche haben will. Die Abfallentsorgung steht dabei zwar nicht im Vordergrund, spielt aber dennoch eine große Rolle bei der Nutzung aller Möglichkeiten einer modernen Küche. Auch nach vielen Jahren sollen die Produkte noch einwandfrei die Arbeit unterstützen und erleichtern. Bei Hailo wird jedes neu entwickelte Produkt erst einmal einem Dauertest unterzogen, denn unter "Made in Germany" verstehen wir wirklich das, was unsere Kunden mit dem Marktführer der Kücheneinbautechnik verbinden: Erstklassige Qualität und innovative Lösungen, die das Arbeiten in der Küche leichter und schöner machen. Das dürfen Sie von uns erwarten und daran dürfen Sie uns messen, denn diesen Anspruch wollen wir jederzeit uneingeschränkt erfüllen!

Hailo – The Brand that stands for Quality.

A kitchen needs to be perfectly equipped if you want to enjoy cooking or any of the other work that goes on in a kitchen. Waste disposal may not be the first thing that comes to mind in that regard, but it has a significant role to play when it comes to exploiting all the possibilities of the modern kitchen. The products should still work perfectly and make life easier, even after many years. At Hailo, every new product we develop first undergoes an endurance test. That's because we understand "Made in Germany" to mean precisely what our customers expect of the market leader in fitted kitchen technology: first-class quality and innovative solutions that make working in the kitchen easier and more enjoyable. That's what you can expect from us and what you should measure us by, because we want to fully meet this standard at all times!

Hailo – Eine starke Marke punktet mit Kompetenz

Hailo – A strong brand with the mark of expertise



Der rote Punkt ist unser Markenzeichen.

Er steht für Qualitäts-Produkte, die das Leben und Arbeiten im Haushalt angenehmer machen, aber auch für technische Lösungen in Bereichen wie Kücheneinbautechnik, professionelle Steigtechnik und gewerbliche Abfalltechnik. Hailo hat es durch langjähriges Know-how und die permanente Sorge um die Bedürfnisse seiner Kunden geschafft, eine Marke zu werden, der sowohl die Hausfrau als auch der professionelle Entscheider vertrauen. Unser ständiger Antrieb ist die Entwicklung von innovativen und nutzbringenden Produktlösungen.

The red dot is our trademark.

It stands for quality products that make life and housework better, but also for technical solutions required for fitted kitchen design, professional ladder systems and commercial waste systems. With the expertise it has accumulated over many years of expertise and its ongoing attention to the needs of its customers, Hailo has become a brand you can trust – when doing jobs at home or as a professional investment. We are constantly driven to develop innovative and beneficial product solutions.

Die dynamischen Veränderungen im Markt und unser Know-how in der Kücheneinbautechnik haben uns zu einem zuverlässigen Partner bei den führenden Küchenherstellern gemacht.

Hailo bietet innovative Lösungskonzepte.

The dynamic changes in the market and our know-how in kitchen built-in-technology made us a reliable partner for the leading kitchen manufacturers.

Hailo provides innovative concept solutions.



Hailo Wind Systems
Komplette Turmausrüstungs-
Systeme aus einer Hand.

Hailo Wind Systems
Complete Tower Kit
Supply Solutions.

Hailo Professional
Steigtechnik und Leitersysteme
für Gebäude und Zugänge aller Art.

Hailo Professional
Ladder systems for buildings
and access of any kind.

Hailo Commercial
Abfallsammler, Wertstoffbehälter und
Leitern für Industrie und Gewerbe.

Hailo Commercial
Waste bins, recycling containers and
ladders for industry and professionals.

Hailo Konsumgüter
Steiggeräte für Haus und Garten,
Abfallsammler für Küche und Bad.

Hailo Consumer Goods
Ladders for home and garden,
waste bins for the kitchen and bathroom.

Hailo Einbautechnik
Abfalltrenn- und Ordnungssysteme
für die Küchenmöbelindustrie.

Hailo Built-In-Technology
Waste separation and storage systems
for the kitchen industry.



Hailo – Ein starkes Team
Hailo – a strong team

Ob kundenspezifische Einbaulösungen, standardisierte Produkte, Beratung für praktische Produktkombinationen – ein kompetentes und motiviertes Team mit großem Knowhow und langjähriger Erfahrung steht Ihnen in allen Belangen gerne zur Verfügung!

Whether you're looking for customer-specific fitted solutions, standardised products or advice on useful product combinations, our professional and dedicated team is at your service to offer their great expertise and long-standing experience and will be delighted to assist you with all your needs.

Hailo – Messen
Hailo – Fairs



Hailo Einbautechnik ist auf den für unsere Kunden relevanten Messen präsent. Hier zeigen wir einen repräsentativen Auszug aus unserem umfangreichen Produktportfolio.

Hier stehen wir mit kompetentem Personal für Fachgespräche bereit.

Hier werden zusammen mit Ihnen, bei Bedarf, Neuheiten besprochen und entwickelt.

Wir laden Sie herzlich ein, uns auf folgenden Messen zu kontaktieren: Interzum / SICAM / ZOW

Hailo Built-In Technology attends trade fairs that are relevant to our customers.

This is where we exhibit a representative selection of our comprehensive product portfolio.

It is where our professional staff are waiting to discuss your specific needs.

And it is where – together with you – new products and services are discussed and developed as required.

We cordially invite you to contact us at the following trade fairs: Interzum / SICAM / ZOW

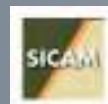
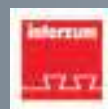

Hailo – Ausgezeichnetes Design

Hailo – Awarded designs

Unsere Einbau-Produkte bieten mehr als Funktionalität und Qualität: Für ihr außergewöhnliches Design erhielten sie bereits viele Auszeichnungen wie den red dot award, den iF Design Award und den Interzum Award.

Our built-in products offer more than just functionality and quality. They have already received a number of awards for their exceptional design, such as the red dot award, the iF Design Award and the Interzum Design Award.



reddot award

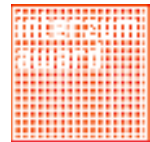

Hailo – Eine starke Marke punktet mit Montagefreundlichkeit und Service

Hailo - A strong brand with the benefits of easy installation and great service



Übersichtliche Montageanleitungen

Jedem Hailo-Einbau-Produkt liegt eine übersichtliche, bebilderte Montageschablone bei.

Hailo-Montageschablone für den Profi!

Alle Montageanleitungen dienen gleichzeitig als Bohrschablone. Anhalten – markieren – schrauben!

Speziell für Montage-Profis, die öfter Hailo Cargo-Systeme montieren, stehen diese Schablonen nun auch in Kunststoff bzw. Pappe in 3 mm Stärke zur Verfügung.

Clear and illustrated Installation Instructions

All Hailo built-in products are supplied with a clear and illustrated installation template.

The Hailo Installation Template for professionals

All our installation instructions also serve as drill jigs. Hold on – mark – drill! Specially designed for professional fitters who frequently install Hailo Cargo Systems, these templates are now also available in 3 mm thick plastic and/or cardboard.



Montage-Video

Mit einem animiertem Montagevideo werden alle nötigen Arbeitsschritte für Cargo-Systeme anschaulich dargestellt. Video auf der Hailo-Webseite, als Download oder einfach per Smartphone.

Installation video

All the essential steps are clearly presented in an animated installation video. You can download the video on the Hailo website or simply view it online on your smartphone.





Montageanleitungen als PDF-Download
 Auf der Hailo-Webseite stehen alle Montageanleitungen und Maßskizzen als PDF-Download zur Verfügung.

Installation instructions and dimensional diagrams are available as PDFs for downloading

All installation instructions and dimensional diagrams are available on the Hailo website for downloading as PDF files.



Hailo – Eine starke Marke punktet am POS
 Hailo - A strong brand with PoS benefits

Plakate, Displays, Aufkleber etc. für den POS in Küchenstudio und Möbelhandel stellen wir gerne zur Verfügung.
 We would be delighted to supply you with posters, displays, stickers, etc., for PoS use in kitchen showrooms and furniture stores.

Hailo - Digitale Helfer

Hailo - Digital Assistants

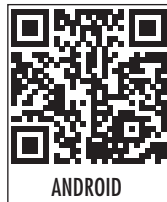

ANDROID



IOS



Mit Hilfe einer App können per Smartphone verschiedene Funktionen der elektronischen Öffnungsunterstützung Libero 2.0 eingestellt werden. Die App ist für Android und iOS erhältlich und steht kostenlos zum Download zur Verfügung.

Konfigurations- und Einstellungsmöglichkeiten:

- LED Leuchte aus/ ein
- Regelung der Auswurfstärke
- Regelung der Sensor-Empfindlichkeit

Weitere nützliche Funktionen werden die Hailo App zukünftig ergänzen.

By means of an App various features of the "Libero 2.0" electronic opener may be set by SmartPhone.

This App is available for free download, for Android and iOS phones.

Configurations and Adjustments:

- LED indicator Light off / on
- Adjustment of push-out Force
- Setting of Sensor-Sensitivity

Additional useful features will complete the Hailo App in future.

Hailo – 100.000 mal getestet

Hailo - 100,000 times tested



Alle Hailo Systeme unterliegen strengsten Qualitätsprüfungen. Eine neue Produktserie geht erst in den Markt, wenn z.B. 100.000 Auszugszyklen unter strengen Laborbedingungen getestet wurden.

Hochwertige Auszugschienen gewährleisten sicheren, ruhigen Lauf – ein Produktleben lang! Man sieht sie nicht, aber man fühlt und spürt sie bei jeder Betätigung. Hailo Einbautechnik erfüllt in allen Belangen die hohen Anforderungen anspruchsvoller Kunden. Dieser Qualitätsanspruch ist uns Verpflichtung. Dazu zählt auch der Einsatz hochwertiger Materialien.

All Hailo Systems are being tested according to the toughest Quality-Control-Requirements.

We would not release any new series for our markets, unless they have, successfully, passed min. 100,000 pullout cycles lifetime tests, with increased trash-load and front-panels attached.

High-end slides ensure a smooth, safe and silent pullout – over the entire lifetime period.

You would hardly see them, but you can feel and realize them during every use. Hailo Built-In Technology fulfills or exceeds the high requirements of our demanding customers. Those quality expectations are our commitments. This, surely, also includes the use of premium materials and components.



Hailo – Eine starke Marke punktet auch Online

Hailo - A strong brand with online benefits as well

PRODUKTE EINBAUVARIANTEN UNTERNEHMEN SERVICE NEWS & PRESSE

HAILO PANTRY-BOX: ORDNUNG UND HYGIENE FÜR FRISCHE LEBENSMITTEL

DIE NEUEN VON HAILO EINBAUTECHNIK

HAILO PANTRY-BOX HAILO LAUNDRY-CARRIER CARGO-SOFT LOW

Übersichtliche Vielfalt

Auf der Hailo Website bieten wir Industrie, Handel und Endkunden gleichermaßen nützliche Informationen zu unseren Produkten und Leistungen. Egal ob Sie per Suchmaske die Artikelnummer oder den Produktnamen eingeben oder ob Sie über die Textnavigation bzw. Bildnavigation etwas suchen – viele Wege führen Sie zur gewünschten Information.

Clean diversity

On the Hailo website, we provide industry, trade and end customers with useful information on our products and services in equal measure. There are many ways to access the information you require: you can enter either the item number or the product name into the search screen or search for something via the navigation bar by text or by image.

www.hailo-einbautechnik.de





Achtung: ausschließlich für Deutschland, Niederlande und Österreich!
Please note: For Germany, the Netherlands and Austria only!



Zubehör & Ersatzteile für Endkunden

Für Handels- und Endkunden in Deutschland, den Niederlande und Österreich bieten wir mit unserem Online-Ersatzteilshop einen gerne genutzten Service. Hier finden Sie passendes Zubehör und Ersatzteile zu Hailo-Einbautechnik-Produkten. Bequem online bestellen. shop.hailo-einbautechnik.de

Accessories & Spare parts for customers

If you're a trade customer or end customer in Germany, the Netherlands or Austria, we provide a service you'll love to use: our Online Parts Shop. Here, you'll find the right accessories and parts for Hailo Built-In Technology products. Order online at your convenience. shop.hailo-einbautechnik.de

Hailo – Eine starke Marke punktet mit System und Vielfalt

Hailo - A strong brand with the benefits of system design and diversity

1 Produktart Product

AS = Abfallsammler Waste bins

OS = Ordnungssysteme Organizer systems

CS = Customized Solution

FS = Funktionssysteme Functional systems

2 Serienname Name of the series

3 Schrankbreite (in mm) Cabinet width (in mm)

Angabe Schrankbreite entfällt bei Systemen,
die in unterschiedlich breite Schränke passen.

The cabinet widths are not mentioned for products
or series that are designed for varying unit widths.

4 Bezeichnung des Inneneimers Name of inner bins

Beispiel: 20/10/10/D
= 1 x 20L, 2 x 10L + 1x Deckel

Example: 20/10/10/D
= 1 x 20L, 2 x 10L + 1 x Lid

5 Zubehör Accessories

D = Deckel Lid

KS = Kehrset Dust-pan & -brush

P = Putzmittelkorb Cleaners basket

U = Utensiliendepot Utensil bowl

K = Kitty

ME = Multifunktionseimer Multifunctional bucket

Beispiel: 15/15/7,5/7,5/D/KS/U/U
= 2 x 15L, 2 x 7,5L + Deckel; Kehrset;
2 x Utensiliendepot

Example: 15/15/7,5/7,5/D/KS/U/U
= 2 x 15L, 2 x 7,5L + Lid;
Storage compartments; 2 x Utensil bowl

Das D (Deckel) wird immer dem Inneneimer
angehängt, der mit Deckel ausgestattet ist.

The letter "D" (for Deckel = Lid) is printed right behind
the inner bin that comes with that individual plastic Lid.

Beispiel: Hailo AS Euro Cargo 600 ST
38/38/12/D/2,5

Hier bezieht sich das "D" auf den Deckel des
vorhergenannten Inneneimer 12

Example: Hailo AS Euro Cargo 600 ST
38/38/12/D/2.5

The letter "D" refers to the Deckel i.e. to the
Lid for the earlier mentioned 12 L inner bin.

6 Farben Colour

hellgrau light grey
 dunkelgrau dark grey
 creme cream
 weiß white
 braun brown
 silber silver

7 Passende Müllbeutel Matching bin liners



Beispiel: Example:

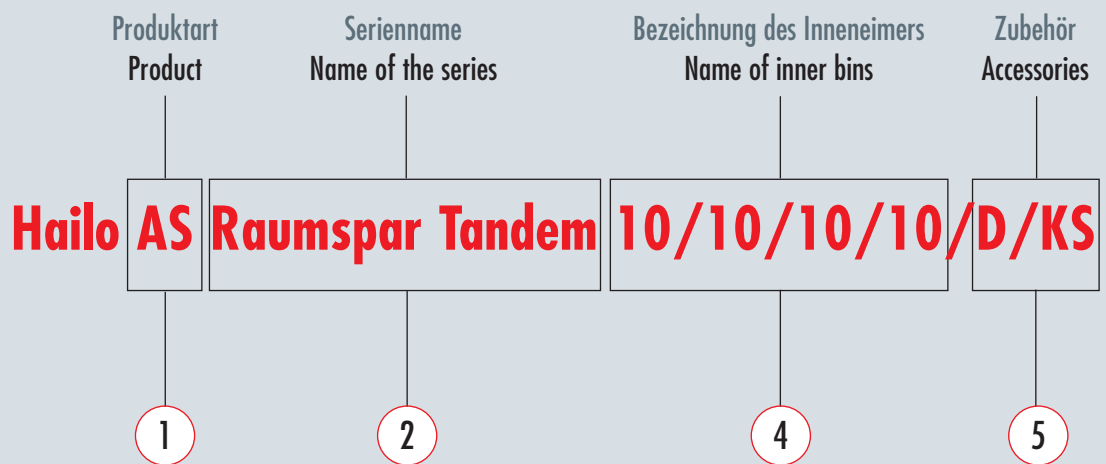

Beispiel: Example:

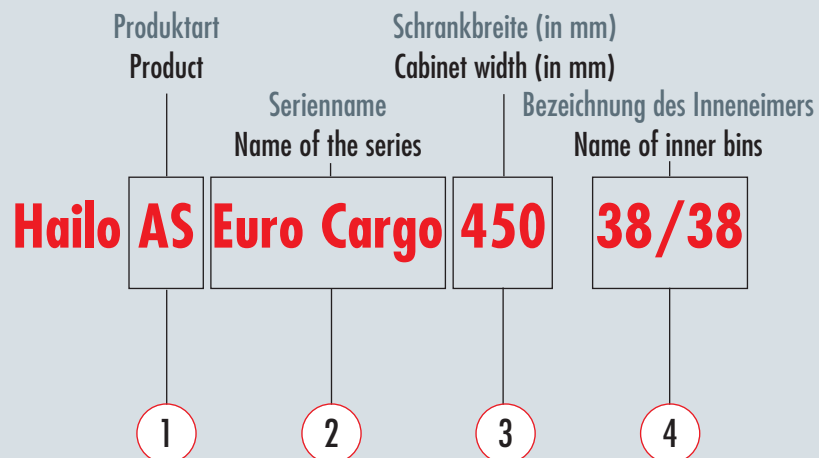

Küchen-Einbautechnik, *passgenau!*

Kitchen Built-in Technology *which always fits!*



Schrankbreiten / Cabinet width:



Swing

Einbau-Systeme für Drehtürschränke

Fitment Systems for hinged door cabinets

30 cm Breite/Width	Seite/ Page	21
40 cm Breite/Width	Seite/ Page	47
45 cm Breite/Width	Seite/ Page	75
50 cm Breite/Width	Seite/ Page	101
60 cm Breite/Width	Seite/ Page	121
Diagonal-Eckspülenschrank	Seite/ Page	153
Diagonal door corner-sink-cabinets		



Slide

Einbau-Systeme mit Frontanbindung

Fitment Systems for front-mount-door cabinets

30 cm Breite/Width	Seite/ Page	33
40 cm Breite/Width	Seite/ Page	69
45 cm Breite/Width	Seite/ Page	85
50 cm Breite/Width	Seite/ Page	105
60 cm Breite/Width	Seite/ Page	125



Inset

Einbau-Systeme zum Einsatz in Schubkästen

Fitment Systems for installation into standard-drawers

30 cm Breite/Width	Seite/ Page	41
45 cm Breite/Width	Seite/ Page	95
50 cm Breite/Width	Seite/ Page	115
60 cm Breite/Width	Seite/ Page	137
80 cm Breite/Width	Seite/ Page	143
90 cm Breite/Width	Seite/ Page	147

Abfallsammler und Abfalltrennsysteme

Waste bins and waste separation systems



Ordnungssysteme
Organizer systems

Seite 159
Page 159



Funktionssysteme
Functional systems

Seite 195
Page 195



Wäschepflege / Hauswirtschaftsraum
Laundry Care / Utility Room

Seite 217
Page 217

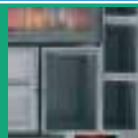

Eimer, Einsätze, Zubehör
Bins, Inserts, Accessories

Seite 241
Page 241



Kundenspezifische Lösungen
Customized Solutions

Seite 268
Page 268

Abfallsammler & Abfalltrennsysteme

Waste bins and waste separation systems



Abfallsammler und Abfalltrennsysteme Waste bins and waste separation systems



Schrankbreite:
Cabinet width:

30 cm



Seite/ Page 21 - 45

40 cm



Seite/ Page 47 - 73

45 cm



Seite/ Page 75 - 99

50 cm



Seite/ Page 101 - 119

60 cm



Seite/ Page 121 - 141

80 cm



Seite/ Page 143 - 145

90 cm



Seite/ Page 147 - 157



Übrigens, wussten Sie, ...

dass der Hailo Tandem mit über 12 Mio Exemplaren das meistverkaufte Einbau-Abfalltrennsystem der Welt ist?

By the way, did you know...

that the Hailo Tandem is the most sold fitted waste separation system in the world, with more than 12 million units sold?

Swing

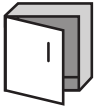

Für Schränke ab 300 mm Breite mit Drehtür
For hinged door cabinets from 300 mm width



30 cm

Swing



Für Schränke ab 300 mm Breite mit Drehtür
For hinged door cabinets from 300 mm width

Tandem



Hailo AS Tandem 15/15 hellgrau

3666811



- Trennung: 2-fach
- Abfalleimer: 2 x 15 l, Gesamtvolumen 30 l
- **Montageart: Bodenmontage**
- Auszugsschienen: Vollauszug
- Farbe: Metallteile silberfarben, Kunststoffteile hellgrau
- Produkt-Maße: B x T x H, 251 x 482 x 400 mm
- Verpackungsmaße: B x T x H, 260 x 504 x 420 mm
- Gewicht mit Verpackung: 7,7 kg



Tandem



Hailo AS Tandem 15/15/D hellgrau

3666821



- Trennung: 2-fach
- Abfalleimer: 2 x 15 l, Gesamtvolumen 30 l, 1 x Behälterdeckel 15 l
- **Montageart: Bodenmontage**
- Auszugsschienen: Vollauszug
- Farbe: Metallteile silberfarben, Kunststoffteile hellgrau
- Produkt-Maße: B x T x H, 251 x 482 x 400 mm
- Verpackungsmaße: B x T x H, 260 x 504 x 420 mm
- Gewicht mit Verpackung: 7,8 kg



Tandem



Hailo AS Tandem 24/7 dunkelgrau

3666111



- Trennung: 2-fach
- Abfalleimer: 1 x 24 l, 1 x 7 l, Gesamtvolumen 31 l
- **Montageart: Bodenmontage**
- Auszugsschienen: Vollauszug
- Farbe: Metallteile silberfarben, Kunststoffteile dunkelgrau
- Produkt-Maße: B x T x H, 251 x 482 x 400 mm
- Verpackungsmaße: B x T x H, 260 x 504 x 420 mm
- Gewicht mit Verpackung: 7,05 kg



Passend für Schränke
Suitable for cabinets

30 40 45 50 60 cm

- Separation: 2-fold
- Inner bins: 2 x 15 l, Total capacity 30 l
- **Type of installation: bottom-mounted**
- Slides: full extension
- Colour: Metal parts silver-coloured, Plastic parts light-grey
- Product dimensions: W x D x H, 251 x 482 x 400 mm
- Packing dimensions: W x D x H, 260 x 504 x 420 mm
- Weight incl. packing: 7,7 kg

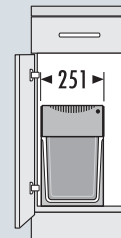
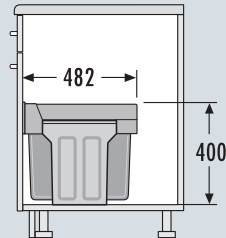

30 cm

Passend für Schränke
Suitable for cabinets

30 40 45 50 60 cm

- Separation: 2-fold
- Inner bins: 2 x 15 l, Total capacity 30 l, 1 x Lid 15 l
- **Type of installation: bottom-mounted**
- Slides: full extension
- Colour: Metal parts silver-coloured, Plastic parts light-grey
- Product dimensions: W x D x H, 251 x 482 x 400 mm
- Packing dimensions: W x D x H, 260 x 504 x 420 mm
- Weight incl. packing: 7,8 kg

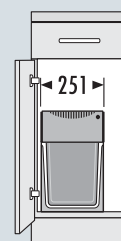
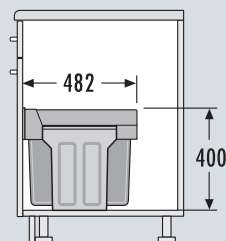

Passend für Schränke
Suitable for cabinets

30 40 45 50 60 cm

- Separation: 2-fold
- Inner bins: 1 x 24 l, 1 x 7 l, Total capacity 31 l
- **Type of installation: bottom-mounted**
- Slides: full extension
- Colour: Metal parts silver-coloured, Plastic parts dark-grey
- Product dimensions: W x D x H, 251 x 482 x 400 mm
- Packing dimensions: W x D x H, 260 x 504 x 420 mm
- Weight incl. packing: 7,05 kg

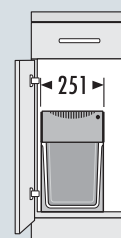
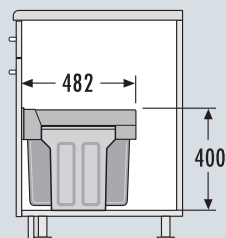

Swing



Für Schränke ab 300 mm Breite mit Drehtür
For hinged door cabinets from 300 mm width

Tandem



Hailo AS Tandem 15/15 dunkelgrau

3666101



- Trennung: 2-fach
- Abfalleimer: 2 x 15 l, Gesamtvolumen 30 l
- **Montageart: Bodenmontage**
- Auszugsschienen: Vollauszug
- Farbe: Metallteile silberfarben, Kunststoffteile dunkelgrau
- Produkt-Maße: B x T x H, 251 x 482 x 400 mm
- Verpackungsmaße: B x T x H, 260 x 504 x 420 mm
- Gewicht mit Verpackung: 7,15 kg



Tandem



Hailo AS Tandem 15/15 weiß

3666001



- Trennung: 2-fach
- Abfalleimer: 2 x 15 l, Gesamtvolumen 30 l
- **Montageart: Bodenmontage**
- Auszugsschienen: Vollauszug
- Farbe: Metallteile weiß, Kunststoffteile weiß
- Produkt-Maße: B x T x H, 251 x 482 x 400 mm
- Verpackungsmaße: B x T x H, 260 x 504 x 420 mm
- Gewicht mit Verpackung: 7,15 kg



Tandem



Hailo AS Tandem 15/15 dunkelgrau

3650101



- Trennung: 2-fach
- Abfalleimer: 2 x 15 l, Gesamtvolumen 30 l
- **Montageart: Bodenmontage**
- Auszugsschienen: Teilauszug
- Farbe: Metallteile silberfarben, Kunststoffteile dunkelgrau
- Produkt-Maße: B x T x H, 252 x 505 x 415 mm
- Verpackungsmaße: B x T x H, 270 x 518 x 440 mm
- Gewicht mit Verpackung: 5 kg



Passend für Schränke
Suitable for cabinets

30 40 45 50 60 cm

- Separation: 2-fold
- Inner bins: 2 x 15 l, Total capacity 30 l
- **Type of installation: bottom-mounted**
- Slides: full extension
- Colour: Metal parts silver-coloured, Plastic parts dark-grey
- Product dimensions: W x D x H, 251 x 482 x 400 mm
- Packing dimensions: W x D x H, 260 x 504 x 420 mm
- Weight incl. packing: 7,15 kg

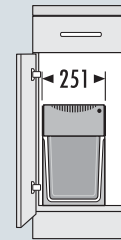
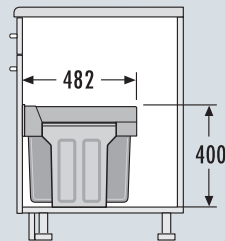

30 cm

Passend für Schränke
Suitable for cabinets

30 40 45 50 60 cm

- Separation: 2-fold
- Inner bins: 2 x 15 l, Total capacity 30 l
- **Type of installation: bottom-mounted**
- Slides: full extension
- Colour: Metal parts white, Plastic parts white
- Product dimensions: W x D x H, 251 x 482 x 400 mm
- Packing dimensions: W x D x H, 260 x 504 x 420 mm
- Weight incl. packing: 7,15 kg

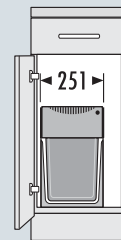
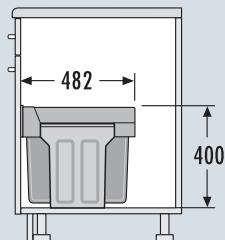

Passend für Schränke
Suitable for cabinets

30 40 45 50 60 cm

- Separation: 2-fold
- Inner bins: 2 x 15 l, Total capacity 30 l
- **Type of installation: bottom-mounted**
- Slides: single extension
- Colour: Metal parts silver-coloured, Plastic parts dark-grey
- Product dimensions: W x D x H, 252 x 505 x 415 mm
- Packing dimensions: W x D x H, 270 x 518 x 440 mm
- Weight incl. packing: 5 kg

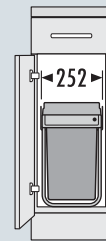
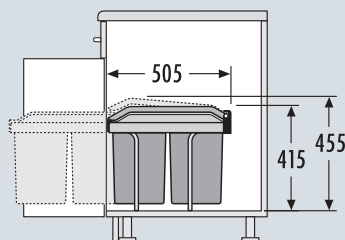

Swing



Für Schränke ab 300 mm Breite mit Drehtür
For hinged door cabinets from 300 mm width

Terzett



Hailo AS Terzett 10/10/10/D hellgrau

3666841



- Trennung: 3-fach
- Abfalleimer: 3 x 10 l, Gesamtvolumen 30 l, 1 x Behälterdeckel 10 l
- **Montageart: Bodenmontage**
- Auszugsschienen: Vollauszug
- Farbe: Metallteile silberfarben, Kunststoffteile hellgrau
- Produkt-Maße: B x T x H, 251 x 482 x 400 mm
- Verpackungsmaße: B x T x H, 260 x 504 x 420 mm
- Gewicht mit Verpackung: 7,1 kg



Terzett



Hailo AS Terzett 15/7/7 dunkelgrau

3666191



- Trennung: 3-fach
- Abfalleimer: 1 x 15 l, 2 x 7 l, Gesamtvolumen 29 l
- **Montageart: Bodenmontage**
- Auszugsschienen: Vollauszug
- Farbe: Metallteile silberfarben, Kunststoffteile dunkelgrau
- Produkt-Maße: B x T x H, 251 x 482 x 400 mm
- Verpackungsmaße: B x T x H, 260 x 504 x 420 mm
- Gewicht mit Verpackung: 7,1 kg



Terzett



Hailo AS Terzett 10/10/10 dunkelgrau

3666131



- Trennung: 3-fach
- Abfalleimer: 3 x 10 l, Gesamtvolumen 30 l
- **Montageart: Bodenmontage**
- Auszugsschienen: Vollauszug
- Farbe: Metallteile silberfarben, Kunststoffteile dunkelgrau
- Produkt-Maße: B x T x H, 251 x 482 x 400 mm
- Verpackungsmaße: B x T x H, 260 x 504 x 420 mm
- Gewicht mit Verpackung: 7,1 kg



Passend für Schränke
Suitable for cabinets

30 40 45 50 60 cm

- Separation: 3-fold
- Inner bins: 3 x 10 l, Total capacity 30 l, 1 x Lid 10 l
- **Type of installation: bottom-mounted**
- Slides: full extension
- Colour: Metal parts silver-coloured, Plastic parts light-grey
- Product dimensions: W x D x H, 251 x 482 x 400 mm
- Packing dimensions: W x D x H, 260 x 504 x 420 mm
- Weight incl. packing: 7,1 kg

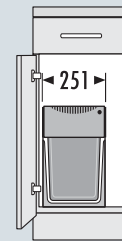
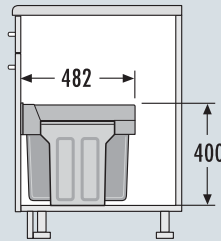

30 cm

Passend für Schränke
Suitable for cabinets

30 40 45 50 60 cm

- Separation: 3-fold
- Inner bins: 1 x 15 l, 2 x 7 l, Total capacity 29 l
- **Type of installation: bottom-mounted**
- Slides: full extension
- Colour: Metal parts silver-coloured, Plastic parts dark-grey
- Product dimensions: W x D x H, 251 x 482 x 400 mm
- Packing dimensions: W x D x H, 260 x 504 x 420 mm
- Weight incl. packing: 7,1 kg

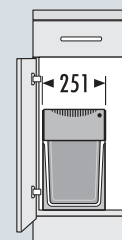
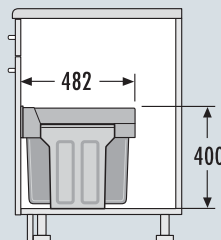

Passend für Schränke
Suitable for cabinets

30 40 45 50 60 cm

- Separation: 3-fold
- Inner bins: 3 x 10 l, Total capacity 30 l
- **Type of installation: bottom-mounted**
- Slides: full extension
- Colour: Metal parts silver-coloured, Plastic parts dark-grey
- Product dimensions: W x D x H, 251 x 482 x 400 mm
- Packing dimensions: W x D x H, 260 x 504 x 420 mm
- Weight incl. packing: 7,1 kg

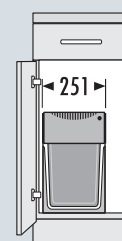
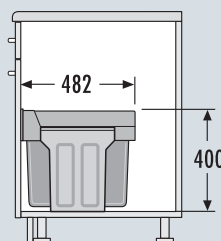

Swing



Für Schränke ab 300 mm Breite mit Drehtür
For hinged door cabinets from 300 mm width

Pico

Hailo AS Pico 5

3505001



- Abfalleimer: 1 x 5 l
- **Montageart: Seitenwandmontage** mit Türmitnehmer
- Farbe: Metallteile weiß, Kunststoffteile weiß
- Produkt-Maße: B x T x H, 175 x 175 x 310 mm
- Verpackungsmaße: B x T x H, 185 x 185 x 310 mm
- Gewicht mit Verpackung: 0,71 kg
- Kann links- wie rechtsseitig montiert werden

Solo

Hailo AS Solo 20 creme/braun

3632001



- Abfalleimer: 1 x 20 l
- **Montageart: Bodenmontage**
- Auszugsschienen: Vollauszug
- Farbe: Metallteile cremeweiß, Kunststoffteile braun
- Produkt-Maße: B x T x H, 242 x 422 x 380 mm
- Verpackungsmaße: B x T x H, 260 x 435 x 390 mm
- Gewicht mit Verpackung: 3,3 kg



Solo

Hailo AS Solo 20 creme

3632011



- Abfalleimer: 1 x 20 l
- **Montageart: Bodenmontage**
- Auszugsschienen: Vollauszug
- Farbe: Metallteile cremeweiß, Kunststoffteile cremeweiß
- Produkt-Maße: B x T x H, 242 x 422 x 380 mm
- Verpackungsmaße: B x T x H, 260 x 435 x 390 mm
- Gewicht mit Verpackung: 3,3 kg



Passend für Schränke
Suitable for cabinets

30 40 45 50 60 cm

- Inner bin: 1 x 5 l
- **Type of installation: side-wall-mounted, with door follower**
- Colour: Metal parts white, Plastic parts white
- Product dimensions: W x D x H, 175 x 175 x 310 mm
- Packing dimensions: W x D x H, 185 x 185 x 310 mm
- Weight incl. packing: 0,71 kg
- May be installed on left or on right sidewall

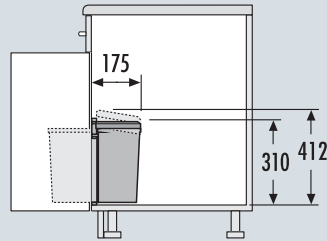

30 cm

Passend für Schränke
Suitable for cabinets

30 40 45 50 60 cm

- Inner bin: 1 x 20 l
- **Type of installation: bottom-mounted**
- Slides: full extension
- Colour: Metal parts cream-white, Plastic parts brown
- Product dimensions: W x D x H, 242 x 422 x 380 mm
- Packing dimensions: W x D x H, 260 x 435 x 390 mm
- Weight incl. packing: 3,3 kg

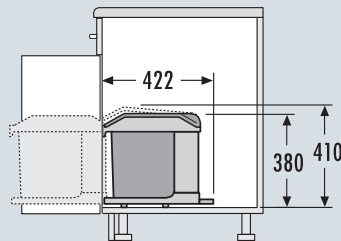

Passend für Schränke
Suitable for cabinets

30 40 45 50 60 cm

- Inner bin: 1 x 20 l
- **Type of installation: bottom-mounted**
- Slides: full extension
- Colour: Metal parts cream-white, Plastic parts cream-white
- Product dimensions: W x D x H, 242 x 422 x 380 mm
- Packing dimensions: W x D x H, 260 x 435 x 390 mm
- Weight incl. packing: 3,3 kg

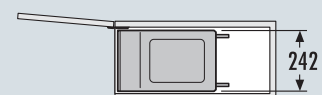
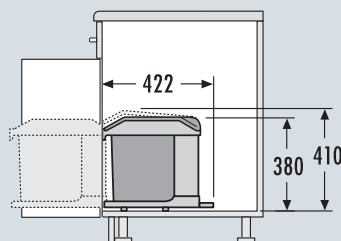

Swing



Für Schränke ab 300 mm Breite mit Drehtür
For hinged door cabinets from 300 mm width

Solo

Hailo AS Solo 20 dunkelgrau

3632101



- Abfalleimer: 1 x 20 l
- **Montageart: Bodenmontage**
- Auszugsschienen: Vollauszug
- Farbe: Metallteile silberfarbig, Kunststoffteile dunkelgrau
- Produkt-Maße: B x T x H, 242 x 422 x 380 mm
- Verpackungsmaße: B x T x H, 260 x 435 x 390 mm
- Gewicht mit Verpackung: 3,3 kg



Passend für Schränke
Suitable for cabinets

30 40 45 50 60 cm



- Inner bin: 1 x 20 l
- **Type of installation: bottom-mounted**
- Slides: full extension
- Colour: Metal parts silver-coloured,
Plastic parts dark-grey
- Product dimensions: W x D x H, 242 x 422 x 380 mm
- Packing dimensions: W x D x H, 260 x 435 x 390 mm
- Weight incl. packing: 3,3 kg

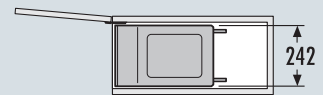
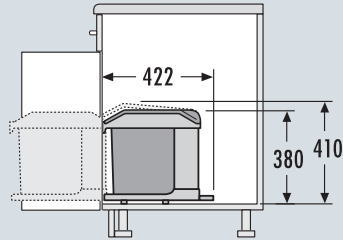

30 cm



Übrigens, wussten Sie, ...

dass Hailo der Erfinder des
Einbau-Abfalltrennsystems ist?

By the way, did you know...

that Hailo is the inventor of
the fitted waste separation system,
the original Hailo Tandem?

Slide



Für Schränke ab 300 mm Breite mit Frontauszug
For front-mount-door cabinets from 300 mm width



30 cm

Slide



Für Schränke ab 300 mm Breite mit Frontauszug
For front-mount-door cabinets from 300 mm width

Cargo Synchro



Hailo AS Cargo Synchro 300 30

3608311



- Abfalleimer: 1 x 30 l
- Montageart: Seitenwandmontage, selbstjustierend 16 - 19 mm
- **Auszugsschienen: abgedeckter, gedämpfter Selbstezug mit synchronisiertem Überauszug**
- Systemtiefe: 403 mm
- Herausfahrbarer Systemdeckel aus Metall/Kunststoff, vollflächig belegt mit rutschfester Gummimatte
- Farbe: Metall- und Kunststoffteile slate-grey
- Produkt-Maße: B x T x H, 262-268 x 403 x 507 mm
- Verpackungsmaße: B x T x H, 545 x 320 x 450 mm
- Gewicht mit Verpackung: 9,4 kg

Euro Cargo S



Hailo AS Euro Cargo S 300 30

3610121



- Abfalleimer: 1 x 30 l
- Montageart: Seitenwandmontage, selbstjustierend 16 - 19 mm
- **Auszugsschienen: abgedeckter, gedämpfter Selbstezug**
- Systemtiefe: 448 mm
- Metallsystemdeckel
- Farbe: Metallteile silberfarben
- Produkt-Maße: B x T x H, 262-268 x 403 x 446 mm
- Verpackungsmaße: B x T x H, 510 x 345 x 415 mm
- Gewicht mit Verpackung: 8,45 kg

Euro Cargo S



Hailo AS Euro Cargo S 300 13/13/D

3610131



- Trennung: 2-fach
- Abfalleimer: 2 x 13 l, Gesamtvolumen 26 l, 1 x Behälterdeckel 13 l
- Montageart: Seitenwandmontage, selbstjustierend 16 - 19 mm
- **Auszugsschienen: abgedeckter, gedämpfter Selbstezug**
- Systemtiefe: 448 mm
- Metallsystemdeckel
- Farbe: Metallteile silberfarben
- Produkt-Maße: B x T x H, 262-268 x 403 x 446 mm
- Verpackungsmaße: B x T x H, 510 x 345 x 415 mm
- Gewicht mit Verpackung: 8,5 kg

- Inner bin: 1 x 30 l
- Type of installation: side-wall-mounted, self-adjusting to 16 - 19 mm side walls
- **Slides: covered, dampened slides with self-closing device with fully synchronized over-travel**
- System-depth: 403 mm
- Pullout metal/ plastic system lid, with anti-slip rubber mat
- Colour: Metal parts powder coated slate-grey, plastic parts slate-grey
- Product dimensions: W x D x H, 262-268 x 403 x 507 mm
- Packing dimensions: W x D x H, 545 x 320 x 450 mm
- Weight incl. packing: 9,4 kg

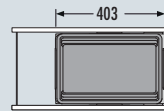
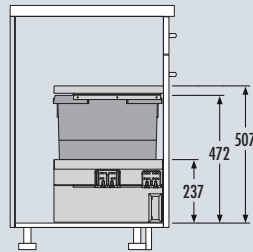

- Inner bin: 1 x 30 l
- Type of installation: side-wall-mounted, self-adjusting to 16 - 19 mm side walls
- **Slides: covered, dampened slides with self-closing device**
- System-depth: 448 mm
- Sheet metal system Lid
- Colour: Frame metal parts silver-coloured
- Product dimensions: W x D x H, 262-268 x 403 x 446 mm
- Packing dimensions: W x D x H, 510 x 345 x 415 mm
- Weight incl. packing: 8,45 kg

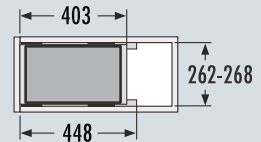
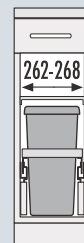
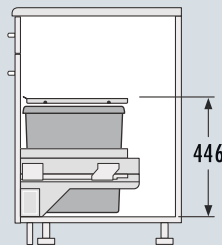

- Separation: 2-fold
- Inner bins: 2 x 13 l, 1 x 13 l, Total capacity 26 l, 1 x Lid 13 l
- Type of installation: side-wall-mounted, self-adjusting to 16 - 19 mm side walls
- **Slides: covered, dampened slides with self-closing device**
- System-depth: 448 mm
- Sheet metal system Lid
- Colour: Frame metal parts silver-coloured
- Product dimensions: W x D x H, 262-268 x 403 x 446 mm
- Packing dimensions: W x D x H, 510 x 345 x 415 mm
- Weight incl. packing: 8,5 kg

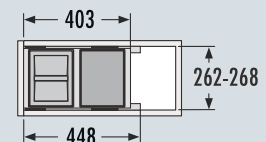
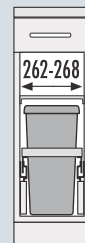
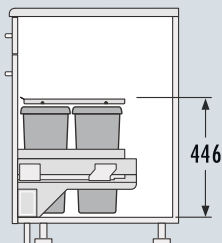

Slide



Für Schränke ab 300 mm Breite mit Frontauszug
For front-mount-door cabinets from 300 mm width

Cargo Soft



Hailo AS Cargo Soft 300 15/10/D

3610341



- Trennung: 2-fach
- Abfalleimer: 1 x 15 l, 1 x 10 l, Gesamtvolumen 25 l
1 x Behälterdeckel 10 l
- Montageart: Seitenwandmontage, selbstjustierend 16 - 19 mm
- **Auszugschienen: abgedeckter, gedämpfter Selbsteinzug**
- Systemtiefe: 448 mm
- Metallsystemdeckel
- Farbe: Metallteile silberfarben
- Produkt-Maße: B x T x H, 262-268 x 403 x 388 mm
- Verpackungsmaße: B x T x H, 465 x 330 x 320 mm
- Gewicht mit Verpackung: 8,5 kg



Cargo Basic

Hailo AS Cargo Basic 300 15/10/D

3609301



- Trennung: 2-fach
- Abfalleimer: 1 x 15 l, 1 x 10 l, Gesamtvolumen 25 l,
1 x Behälterdeckel 10 l
- Montageart: Seitenwandmontage, selbstjustierend 16 - 19 mm
- **Auszugschienen: Überauszug mit Selbsteinzug**
- Systemtiefe: 403 mm
- Metallsystemdeckel
- Farbe: Metallteile silberfarben
- Produkt-Maße: B x T x H, 262-268 x 403 x 388 mm
- Verpackungsmaße: B x T x H, 425 x 273 x 335 mm
- Gewicht mit Verpackung: 9 kg



- Separation: 2-fold
- Inner bins: 1 x 15 l, 1 x 10 l, Total capacity 25 l, 1x Lid 10 l
- Type of installation: side-wall-mounted, self-adjusting to 16 - 19 mm side walls
- Slides: **covered, dampened slides with self-closing device**
- System-depth: 448 mm
- Sheet metal system Lid
- Colour: Frame metal parts silver-coloured
- Product dimensions: W x D x H, 262-268 x 403 x 388 mm
- Packing dimensions: W x D x H, 465 x 330 x 320 mm
- Weight incl. packing: 8,5 kg

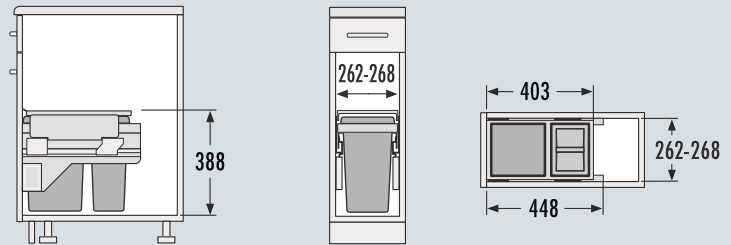

- Separation: 2-fold
- Inner bins: 1 x 15 l, 1 x 10 l, Total capacity 25 l, 1x Lid 10 l
- Type of installation: side-wall-mounted, self-adjusting to 16 - 19 mm side walls
- Slides: **non-dampened slides with self-closing device**
- System-depth: 403 mm
- Sheet metal system Lid
- Colour: Frame metal parts silver-coloured
- Product dimensions: W x D x H, 262-268 x 403 x 388 mm
- Packing dimensions: W x D x H, 425 x 273 x 335 mm
- Weight incl. packing: 9 kg

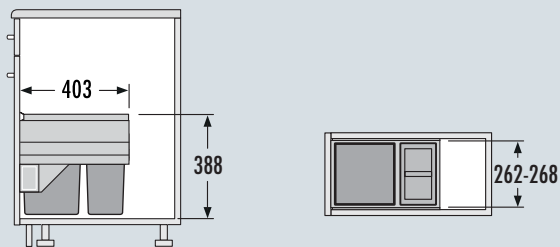

Slide



Für Schränke ab 300 mm Breite mit Frontauszug
For front-mount-door cabinets from 300 mm width

Hailo Kick and Go

Fußhebel (Zubehör für Cargo Basic 3609)

3691401



Fußhebel "Kick and go"
Die Cargos fahren per Fußdruck heraus.

siehe Seite 202

Hailo Libero

Türöffner

3697101



Hailo Libero – Hands Free Opener
Die Öffnungsunterstützung von Hailo für ein automatisches, komfortables Öffnen aller Abfalltrennsysteme mit Frontanbindung und aller Auszugssysteme.
Ausführliche Beschreibung Seite 198

Kann in Verbindung mit Metalltüren, gerahmten Metalltüren und Metall-Sockeln zu Funktionsstörungen führen.

Hailo Libero 2.0

Türöffner

3697201



Hailo Libero – Hands Free Opener
Die Öffnungsunterstützung von Hailo für ein automatisches, komfortables Öffnen aller Abfalltrennsysteme mit Frontanbindung und aller Auszugssysteme.
Ausführliche Beschreibung Seite 200

Foot Pedal

Foot Pedal "Kick and go" for Cargo Basic 3609
The Cargo leaves the cabinet by a light toe-kick – handsfree.

More information: page 202

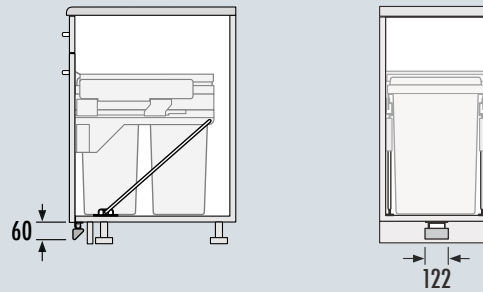

Door Opener

Hailo „Libero“ – Hands Free Opener

Hailo's electronic front-mount-door and drawer-opener „Libero“ offers an automatic, comfortable hands-free opening of all waste-recycling-systems with attached door-panel and of any common, also damped, drawer-mounted systems. With 2-pin Euro-Plug, 230 V, IP 4.1 certified

More information: page 198

If installed behind a door-panel with a metal frame, or behind a metal cabinet-front, or above a metal plinth, malfunctions may occur.

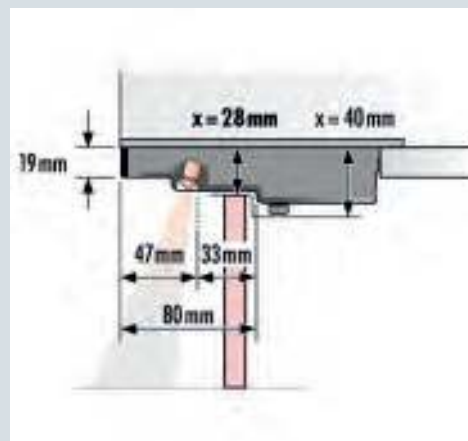

Door Opener

Hailo „Libero“ – Hands Free Opener

Hailo's electronic front-mount-door and drawer-opener „Libero“ offers an automatic, comfortable hands-free opening of all waste-recycling-systems with attached door-panel and of any common, also damped, drawer-mounted systems. With 2-pin Euro-Plug, 230 V, IP 4.1 certified

More information: page 200





Übrigens, wussten Sie, ... dass Hailo Einbautechnik viele Standards durch Innovationen (Rondo, Mono, Tandem, Cargo etc.) gesetzt hat?

By the way, did you know... that Hailo Built-In Technology has set many standards through innovation (Rondo, Mono, Tandem, Cargo etc.)?

Inset



Einsatz für Schränke ab 300 mm Breite mit Frontauszug
For common drawers from 300 mm width



30 cm

Inset



Einsatz für Schränke ab 300 mm Breite mit Frontauszug
For common drawers from 300 mm width

Euro Cargo 30

Hailo AS Euro Cargo 300 38/7

3614301



- Trennung: 2-fach
- Abfalleimer: 1 x 38 l, 1 x 7 l, Gesamtvolumen 45 l
- **Montageart: Schubkastenmontage**, Seitenwandstärke 16 mm
- Schubkasten Nenntiefe \geq 500 mm
- Metallsystemdeckel
- Farbe: Metallteile silberfarben
- Produkt-Maße: B x T x H, 268 x 477 x 560 mm
- Verpackungsmaße: B x T x H, 490 x 290 x 605 mm
- Gewicht mit Verpackung: 5,4 kg

Tandem

Hailo AS Tandem 15/15 dunkelgrau

3663101



- Trennung: 2-fach
- Abfalleimer: 2 x 15 l, Gesamtvolumen 30 l
- **Montageart: Schubkastenmontage**
- Schubkasten Nenntiefe \geq 500 mm
- Farbe: Metallteile silberfarben, Kunststoffteile dunkelgrau
- Produkt-Maße: B x T x H, 254 x 477 x 433 mm
- Verpackungsmaße: B x T x H, 260 x 504 x 420 mm
- Gewicht mit Verpackung: 4,8 kg

- Separation: 2-fold
- Inner bins: 1 x 38 l, 1 x 7 l, Total capacity 45 l
- **Type of installation: inside available drawer, side-wall-thickness 16mm**
- Nominal drawer-depth ≥ 500 mm
- Sheet metal system Lid
- Colour: Frame metal parts silver-coloured
- Product dimensions: W x D x H, 268 x 477 x 560 mm
- Packing dimensions: W x D x H, 490 x 290 x 605 mm
- Weight incl. packing: 5,4 kg

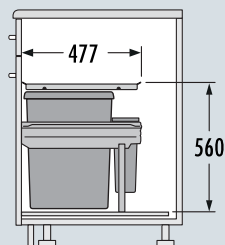

- Separation: 2-fold
- Inner bins: 2x15 l, Total capacity 30 l
- **Type of installation: inside available drawer**
- Nominal drawer-depth ≥ 500 mm
- Colour: Frame metal parts silver-coloured, plastic parts dark-grey
- Product dimensions: W x D x H, 254 x 477 x 433 mm
- Packing dimensions: W x D x H, 260 x 504 x 420 mm
- Weight incl. packing: 4,8 kg

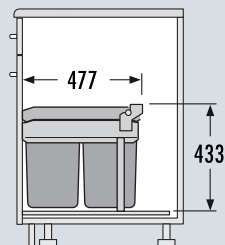

Inset



Einsatz für Schränke ab 300 mm Breite mit Frontauszug For common drawers from 300 mm width

Solo

Hailo AS Solo 20 creme

3633011



- Abfalleimer: 1 x 20 l
- **Montageart: Schubkastenmontage**
- Schubkasten Nenntiefe ≥ 500 mm
- Farbe: Kunststoffteile cremeweiß
- Produkt-Maße: B x T x H, 242 x 422 x 380 mm
- Verpackungsmaße: B x T x H, 260 x 435 x 390 mm
- Gewicht mit Verpackung: 2,2 kg



Solo

Hailo AS Solo 20 dunkelgrau

3633101



- Abfalleimer: 1 x 20 l
- **Montageart: Schubkastenmontage**
- Schubkasten Nenntiefe ≥ 500 mm
- Farbe: Kunststoffteile dunkelgrau
- Produkt-Maße: B x T x H, 242 x 422 x 380 mm
- Verpackungsmaße: B x T x H, 260 x 435 x 390 mm
- Gewicht mit Verpackung: 2,2 kg



- Inner bin: 1 x 20 l
- **Type of installation: inside available drawer**
- Nominal drawer-depth ≥ 500 mm
- Colour: Plastic parts cream-white
- Product dimensions: W x D x H, 242 x 422 x 380 mm
- Packing dimensions: W x D x H, 260 x 435 x 390 mm
- Weight incl. packing: 2,2 kg

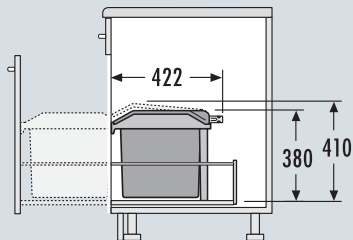

- Inner bin: 1 x 20 l
- **Type of installation: inside available drawer**
- Nominal drawer-depth ≥ 500 mm
- Colour: Plastic parts dark-grey
- Product dimensions: W x D x H, 242 x 422 x 380 mm
- Packing dimensions: W x D x H, 260 x 435 x 390 mm
- Weight incl. packing: 2,2 kg

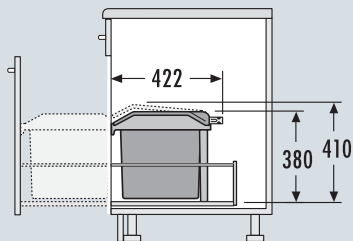



Übrigens, wussten Sie, ...

dass Hailo bereits 1953 den ersten Einbau-Abfallsammler für Küchen auf den Markt brachte?

By the way, did you know...

that Hailo already introduced the first built-in waste bins in 1953?

Swing

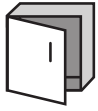

Für Schränke ab 400 mm Breite mit Drehtür
For hinged door cabinets from 400 mm width



40 cm

Swing



Für Schränke ab 400 mm Breite mit Drehtür
For hinged door cabinets from 400 mm width

Solo

Hailo AS Solo 20 creme

3634011



- Abfalleimer: 1 x 20 l
- **Montageart: Bodenmontage**
- Auszugsschienen: Vollauszug mit Ausfahrautomatik
- Farbe: Metallteile cremeweiß, Kunststoffteile cremeweiß
- Produkt-Maße: B x T x H, 242 x 422 x 380 mm
- Verpackungsmaße: B x T x H, 260 x 435 x 390 mm
- Gewicht mit Verpackung: 3,4 kg



Solo

Hailo AS Solo 20 dunkelgrau

3634101



- Abfalleimer: 1 x 20 l
- **Montageart: Bodenmontage**
- Auszugsschienen: Vollauszug mit Ausfahrautomatik
- Farbe: Metallteile silberfarben, Kunststoffteile dunkelgrau
- Produkt-Maße: B x T x H, 242 x 422 x 380 mm
- Verpackungsmaße: B x T x H, 260 x 435 x 390 mm
- Gewicht mit Verpackung: 3,4 kg



Mono

Hailo AS Mono 12 weiß

3512001



- Abfalleimer: 1 x 12 l
- **Montageart: Seitenwandmontage** mit Türmitnehmer
- Federloser, automatischer Dreh-Kipp-Deckel
- Farbe: Metallteile Stahlblech weiß, Kunststoffteile reinweiß
- Produkt-Maße: B x T x H, 290 x 304 x 295 mm
- Verpackungsmaße: B x T x H, 293 x 298 x 298 mm
- Gewicht mit Verpackung: 1,85 kg
- Kann links- wie rechtsseitig montiert werden

Passend für Schränke
Suitable for cabinets

40 45 50 60 cm

- Inner bin: 1 x 20 l
- **Type of installation: bottom-mounted**
- Slides: full extension with automatic door-follower
- Colour: Metal parts cream-white, Plastic parts cream-white
- Product dimensions: W x D x H, 242 x 422 x 380 mm
- Packing dimensions: W x D x H, 260 x 435 x 390 mm
- Weight incl. packing: 3,4 kg

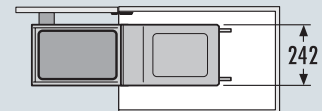
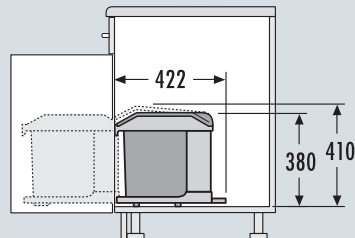

40 cm

Passend für Schränke
Suitable for cabinets

40 45 50 60 cm

- Inner bin: 1 x 20 l
- **Type of installation: bottom-mounted**
- Slides: full extension with automatic door-follower
- Colour: Metal parts silver-coloured, Plastic parts dark-grey
- Product dimensions: W x D x H, 242 x 422 x 380 mm
- Packing dimensions: W x D x H, 260 x 435 x 390 mm
- Weight incl. packing: 3,4 kg

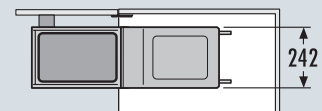
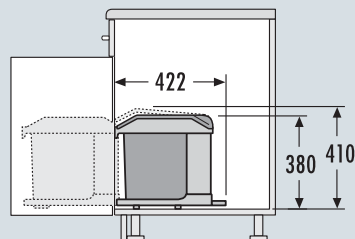

Passend für Schränke
Suitable for cabinets

40 45 50 60 cm

- Inner bin: 1 x 12 l
- **Type of installation: side-wall-mounted, with door follower**
- Springless turn and tilt lid
- Colour: Metal parts sheet steel white, Plastic parts pure white
- Product dimensions: W x D x H, 290 x 304 x 295 mm
- Packing dimensions: W x D x H, 293 x 298 x 298 mm
- Weight incl. packing: 1,85 kg
- May be installed on left or on right sidewall

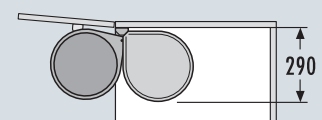
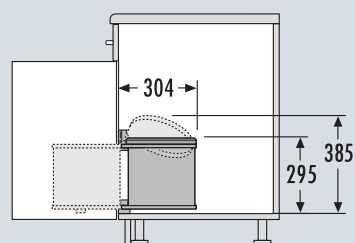

Swing



Für Schränke ab 400 mm Breite mit Drehtür
For hinged door cabinets from 400 mm width

Mono

Hailo AS Mono 12 Edelstahl/weiß

3512011



- Abfalleimer: 1 x 12 l
- **Montageart:** Seitenwandmontage mit Türmitnehmer
- Federloser, automatischer Dreh-Kipp-Deckel
- Farbe: Metallteile Edelstahl, Kunststoffteile reinweiß
- Produkt-Maße: B x T x H, 290 x 304 x 295 mm
- Verpackungsmaße: B x T x H, 293 x 298 x 298 mm
- Gewicht mit Verpackung: 1,85 kg
- Kann links- wie rechtsseitig montiert werden

Mono

Hailo AS Mono 12 Edelstahl/schwarz

3512031



- Abfalleimer: 1 x 12 l
- **Montageart:** Seitenwandmontage mit Türmitnehmer
- Federloser, automatischer Dreh-Kipp-Deckel
- Farbe: Metallteile Edelstahl, Kunststoffteile schwarz
- Produkt-Maße: B x T x H, 290 x 304 x 295 mm
- Verpackungsmaße: B x T x H, 293 x 298 x 298 mm
- Gewicht mit Verpackung: 1,85 kg
- Kann links- wie rechtsseitig montiert werden

Mono

Hailo AS Mono 12 creme

3512051



- Abfalleimer: 1 x 12 l
- **Montageart:** Seitenwandmontage mit Türmitnehmer
- Federloser, automatischer Dreh-Kipp-Deckel
- Farbe: Metallteile Stahlblech cremeweiß, Kunststoffteile cremeweiß
- Produkt-Maße: B x T x H, 290 x 304 x 295 mm
- Verpackungsmaße: B x T x H, 293 x 298 x 298 mm
- Gewicht mit Verpackung: 1,85 kg
- Kann links- wie rechtsseitig montiert werden

Passend für Schränke
Suitable for cabinets

40 45 50 60 cm

- Inner bin: 1 x 12 l
- **Type of installation: side-wall-mounted, with door follower**
- Springless turn and tilt lid
- Colour: Metal parts stainless steel, Plastic parts pure white
- Product dimensions: W x D x H, 290 x 304 x 295 mm
- Packing dimensions: W x D x H, 293 x 298 x 298 mm
- Weight incl. packing: 1,85 kg
- May be installed on left or on right sidewall

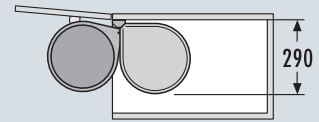
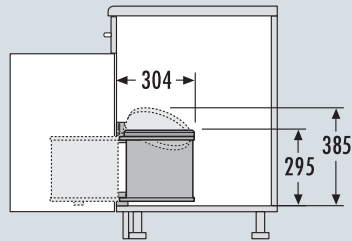

40 cm

Passend für Schränke
Suitable for cabinets

40 45 50 60 cm

- Inner bin: 1 x 12 l
- **Type of installation: side-wall-mounted, with door follower**
- Springless turn and tilt lid
- Colour: Metal parts stainless steel, Plastic parts black
- Product dimensions: W x D x H, 290 x 304 x 295 mm
- Packing dimensions: W x D x H, 293 x 298 x 298 mm
- Weight incl. packing: 1,85 kg
- May be installed on left or on right sidewall

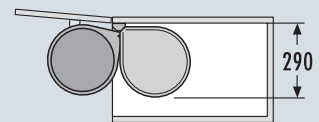
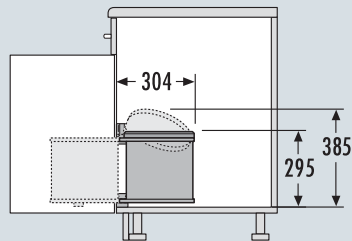

Passend für Schränke
Suitable for cabinets

40 45 50 60 cm

- Inner bin: 1 x 12 l
- **Type of installation: side-wall-mounted, with door follower**
- Springless turn and tilt lid
- Colour: Metal parts sheet steel cream-white, Plastic parts cream-white
- Product dimensions: W x D x H, 290 x 304 x 295 mm
- Packing dimensions: W x D x H, 293 x 298 x 298 mm
- Weight incl. packing: 1,85 kg
- May be installed on left or on right sidewall

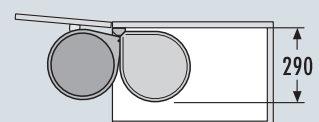
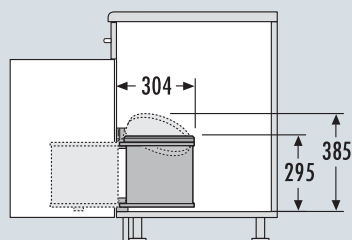

Swing



Für Schränke ab 400 mm Breite mit Drehtür
For hinged door cabinets from 400 mm width

Mono

Hailo AS Mono 15 weiß

3515001



- Abfalleimer: 1 x 15 l
- **Montageart:** Seitenwandmontage mit Türmitnehmer
- Federloser, automatischer Dreh-Kipp-Deckel
- Farbe: Metallteile Stahlblech weiß, Kunststoffteile reinweiß
- Produkt-Maße: B x T x H, 290 x 304 x 365 mm
- Verpackungsmaße: B x T x H, 298 x 298 x 363 mm
- Gewicht mit Verpackung: 2,05 kg
- Kann links- wie rechtsseitig montiert werden

Mono

Hailo AS Mono 15 Edelstahl/weiß

3515011



- Abfalleimer: 1 x 15 l
- **Montageart:** Seitenwandmontage mit Türmitnehmer
- Federloser, automatischer Dreh-Kipp-Deckel
- Farbe: Metallteile Edelstahl, Kunststoffteile reinweiß
- Produkt-Maße: B x T x H, 290 x 304 x 365 mm
- Verpackungsmaße: B x T x H, 298 x 298 x 363 mm
- Gewicht mit Verpackung: 2,05 kg
- Kann links- wie rechtsseitig montiert werden

Mono

Hailo AS Mono 15 Edelstahl/schwarz

3515031



- Abfalleimer: 1 x 15 l
- **Montageart:** Seitenwandmontage mit Türmitnehmer
- Federloser, automatischer Dreh-Kipp-Deckel
- Farbe: Metallteile Edelstahl, Kunststoffteile schwarz
- Produkt-Maße: B x T x H, 290 x 304 x 365 mm
- Verpackungsmaße: B x T x H, 298 x 298 x 363 mm
- Gewicht mit Verpackung: 2,05 kg
- Kann links- wie rechtsseitig montiert werden

Passend für Schränke
Suitable for cabinets

40

45

50

60

cm

- Inner bin: 1 x 15 l
- **Type of installation: side-wall-mounted, with door follower**
- Springless turn and tilt lid
- Colour: Metal parts sheet steel white, Plastic parts pure white
- Product dimensions: W x D x H, 290 x 304 x 365 mm
- Packing dimensions: W x D x H, 298 x 298 x 363 mm
- Weight incl. packing: 2,05 kg
- May be installed on left or on right sidewall

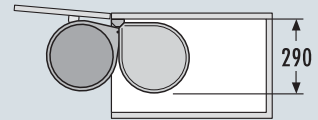
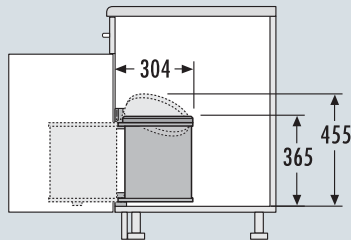

40 cm

Passend für Schränke
Suitable for cabinets

40

45

50

60

cm

- Inner bin: 1 x 15 l
- **Type of installation: side-wall-mounted, with door follower**
- Springless turn and tilt lid
- Colour: Metal parts stainless steel, Plastic parts pure white
- Product dimensions: W x D x H, 290 x 304 x 365 mm
- Packing dimensions: W x D x H, 298 x 298 x 363 mm
- Weight incl. packing: 2,05 kg
- May be installed on left or on right sidewall

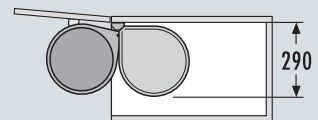
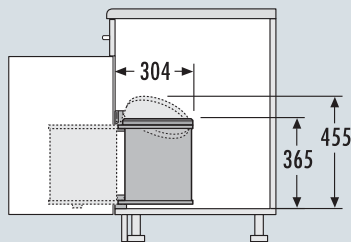

Passend für Schränke
Suitable for cabinets

40

45

50

60

cm

- Inner bin: 1 x 15 l
- **Type of installation: side-wall-mounted, with door follower**
- Springless turn and tilt lid
- Colour: Metal parts stainless steel, Plastic parts black
- Product dimensions: W x D x H, 290 x 304 x 365 mm
- Packing dimensions: W x D x H, 298 x 298 x 363 mm
- Weight incl. packing: 2,05 kg
- May be installed on left or on right sidewall

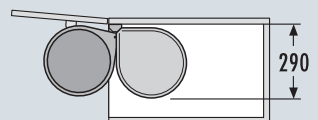
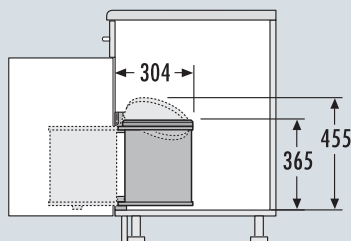



Mono

Hailo AS Mono 15 creme

3515051



- Abfalleimer: 1 x 15 l
- **Montageart:** Seitenwandmontage mit Türmitnehmer
- Federloser, automatischer Dreh-Kipp-Deckel
- Farbe: Metallteile Stahlblech cremeweiß, Kunststoffteile cremeweiß
- Produkt-Maße: B x T x H, 290 x 304 x 365 mm
- Verpackungsmaße: B x T x H, 298 x 298 x 363 mm
- Gewicht mit Verpackung: 2,05 kg
- Kann links- wie rechtsseitig montiert werden

Big Box

Hailo AS Big Box 15 weiß/braun

3715001



- Abfalleimer: 1 x 15 l
- **Montageart:** Seitenwandmontage mit Türmitnehmer
- Automatischer Feder-Hubdeckel
- Farbe: Metallteile Stahlblech weiß, Kunststoffteile braun
- Produkt-Maße: B x T x H, 306 x 306 x 335 mm
- Verpackungsmaße: B x T x H, 298 x 298 x 363 mm
- Gewicht mit Verpackung: 2,5 kg
- Kann links- wie rechtsseitig montiert werden

ACHTUNG: nicht geeignet für gedämpfte Scharniere.

Big Box

Hailo AS Big Box 15 Edelstahl/braun

3715101



- Abfalleimer: 1 x 15 l
- **Montageart:** Seitenwandmontage mit Türmitnehmer
- Automatischer Feder-Hubdeckel
- Farbe: Metallteile Edelstahl, Kunststoffteile braun
- Produkt-Maße: B x T x H, 306 x 306 x 335 mm
- Verpackungsmaße: B x T x H, 298 x 298 x 363 mm
- Gewicht mit Verpackung: 2,5 kg
- Kann links- wie rechtsseitig montiert werden

ACHTUNG: nicht geeignet für gedämpfte Scharniere.

Passend für Schränke
Suitable for cabinets

40

45

50

60

cm

- Inner bin: 1 x 15 l
- **Type of installation: side-wall-mounted, with door follower**
- Springless turn and tilt lid
- Colour: Metal parts sheet steel cream-white, Plastic parts cream-white
- Product dimensions: W x D x H, 290 x 304 x 365 mm
- Packing dimensions: W x D x H, 298 x 298 x 363 mm
- Weight incl. packing: 2,05 kg
- May be installed on left or on right sidewall

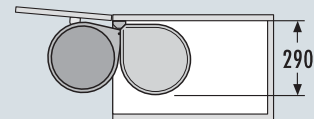
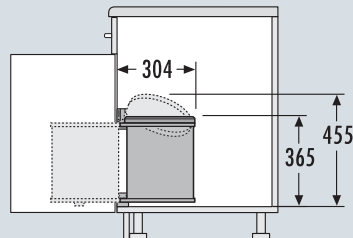

40 cm

Passend für Schränke
Suitable for cabinets

40

45

50

60

cm

- Inner bin: 1 x 15 l
- **Type of installation: side-wall-mounted, with door follower**
- Automatic spring-loaded, lifted lid
- Colour: Metal parts sheet steel white, Plastic parts brown
- Product dimensions: W x D x H, 306 x 306 x 335 mm
- Packing dimensions: W x D x H, 298 x 298 x 363 mm
- Weight incl. packing: 2,5 kg
- May be installed on left or on right sidewall

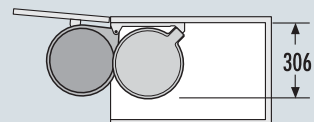
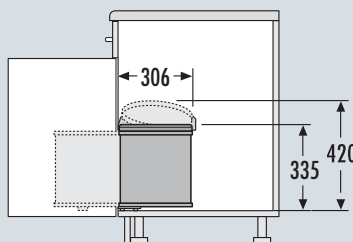

Attention! Not suitable in combination with dampened door hinges

Passend für Schränke
Suitable for cabinets

40

45

50

60

cm

- Inner bin: 1 x 15 l
- **Type of installation: side-wall-mounted, with door follower**
- Automatic spring-loaded, lifted lid
- Colour: Metal parts stainless steel, Plastic parts brown
- Product dimensions: W x D x H, 306 x 306 x 335 mm
- Packing dimensions: W x D x H, 298 x 298 x 363 mm
- Weight incl. packing: 2,5 kg
- May be installed on left or on right sidewall

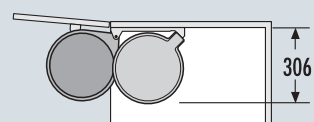
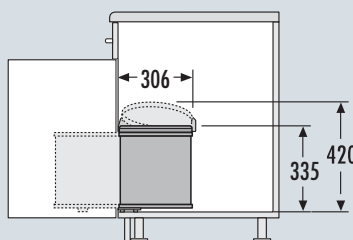

Attention! Not suitable in combination with dampened door hinges



Big Box

Hailo AS Big Box 15 Edelstahl/weiß

3715191



- Abfalleimer: 1 x 15 l
- **Montageart:** Seitenwandmontage mit Türmitnehmer
- Automatischer Feder-Hubdeckel
- Farbe: Metallteile Edelstahl, Kunststoffteile weiß
- Produkt-Maße: B x T x H, 306 x 306 x 335 mm
- Verpackungsmaße: B x T x H, 298 x 298 x 363 mm
- Gewicht mit Verpackung: 2,5 kg
- Kann links- wie rechtsseitig montiert werden

ACHTUNG: nicht geeignet für gedämpfte Scharniere.

Big Box

Hailo AS Big Box 15 silber/schwarz

3715211



- Abfalleimer: 1 x 15 l
- **Montageart:** Seitenwandmontage mit Türmitnehmer
- Automatischer Feder-Hubdeckel
- Farbe: Metallteile Stahlblech silberfarben, Kunststoffteile schwarz
- Produkt-Maße: B x T x H, 306 x 306 x 335 mm
- Verpackungsmaße: B x T x H, 298 x 298 x 363 mm
- Gewicht mit Verpackung: 2,5 kg
- Kann links- wie rechtsseitig montiert werden

ACHTUNG: nicht geeignet für gedämpfte Scharniere.

Big Box

Hailo AS Big Box 15 weiß

3715901



- Abfalleimer: 1 x 15 l
- **Montageart:** Seitenwandmontage mit Türmitnehmer
- Automatischer Feder-Hubdeckel
- Farbe: Metallteile Stahlblech weiß, Kunststoffteile weiß
- Produkt-Maße: B x T x H, 306 x 306 x 335 mm
- Verpackungsmaße: B x T x H, 298 x 298 x 363 mm
- Gewicht mit Verpackung: 2,5 kg
- Kann links- wie rechtsseitig montiert werden

ACHTUNG: nicht geeignet für gedämpfte Scharniere.

Passend für Schränke
Suitable for cabinets

40

45

50

60

cm

- Inner bin: 1 x 15 l
- **Type of installation: side-wall-mounted, with door follower**
- Automatic spring-loaded, lifted lid
- Colour: Metal parts stainless steel, Plastic parts white
- Product dimensions: W x D x H, 306 x 306 x 335 mm
- Packing dimensions: W x D x H, 298 x 298 x 363 mm
- Weight incl. packing: 2,5 kg
- May be installed on left or on right sidewall

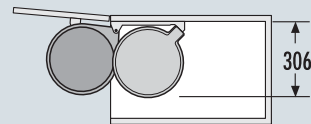
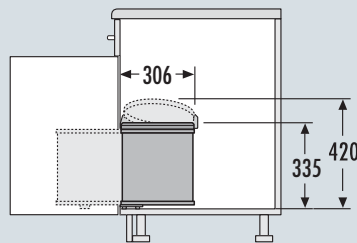

Attention! Not suitable in combination with dampened door hinges

40 cm

Passend für Schränke
Suitable for cabinets

40

45

50

60

cm

- Inner bin: 1 x 15 l
- **Type of installation: side-wall-mounted, with door follower**
- Automatic spring-loaded, lifted lid
- Colour: Metal parts sheet steel silver-coated, Plastic parts black
- Product dimensions: W x D x H, 306 x 306 x 335 mm
- Packing dimensions: W x D x H, 298 x 298 x 363 mm
- Weight incl. packing: 2,5 kg
- May be installed on left or on right sidewall

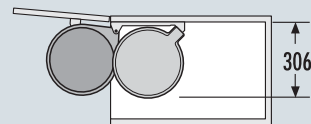
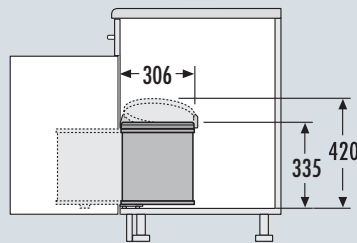

Attention! Not suitable in combination with dampened door hinges

Passend für Schränke
Suitable for cabinets

40

45

50

60

cm

- Inner bin: 1 x 15 l
- **Type of installation: side-wall-mounted, with door follower**
- Automatic spring-loaded, lifted lid
- Colour: Metal parts sheet steel white, Plastic parts white
- Product dimensions: W x D x H, 306 x 306 x 335 mm
- Packing dimensions: W x D x H, 298 x 298 x 363 mm
- Weight incl. packing: 2,5 kg
- May be installed on left or on right sidewall

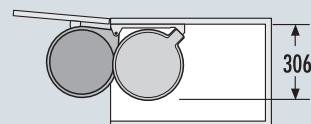
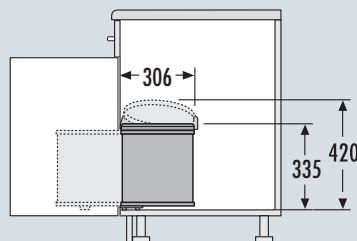

Attention! Not suitable in combination with dampened door hinges

Swing



Für Schränke ab 400 mm Breite mit Drehtür
For hinged door cabinets from 400 mm width

Big Box

Hailo AS Big Box 15 Edelstahl/braun

3725101



- Abfalleimer: 1 x 15 l
 - **Montageart:** Seitenwandmontage mit Türmitnehmer
 - Automatischer Feder-Hubdeckel
 - Farbe: Metallteile Edelstahl, Deckel Alu, Kunststoffteile braun
 - Produkt-Maße: B x T x H, 306 x 306 x 335 mm
 - Verpackungsmaße: B x T x H, 298 x 298 x 363 mm
 - Gewicht mit Verpackung: 2,5 kg
 - Kann links- wie rechtsseitig montiert werden
- ACHTUNG: nicht geeignet für gedämpfte Scharniere.

Big Box

Hailo AS Big Box 20 weiß/braun

3720001



- Abfalleimer: 1 x 20 l
 - **Montageart:** Seitenwandmontage mit Türmitnehmer
 - Automatischer Feder-Hubdeckel
 - Farbe: Metallteile Stahlblech Weiß, Deckel Alu, Kunststoffteile braun
 - Produkt-Maße: B x T x H, 306 x 306 x 450 mm
 - Verpackungsmaße: B x T x H, 295 x 295 x 431 mm
 - Gewicht mit Verpackung: 2,8 kg
 - Kann links- wie rechtsseitig montiert werden
- ACHTUNG: nicht geeignet für gedämpfte Scharniere.

Big Box

Hailo AS Big Box 20 Edelstahl/braun

3720101



- Abfalleimer: 1 x 20 l
 - **Montageart:** Seitenwandmontage mit Türmitnehmer
 - Automatischer Feder-Hubdeckel
 - Farbe: Metallteile Edelstahl, Deckel Alu, Kunststoffteile braun
 - Produkt-Maße: B x T x H, 306 x 306 x 450 mm
 - Verpackungsmaße: B x T x H, 295 x 295 x 431 mm
 - Gewicht mit Verpackung: 2,8 kg
 - Kann links- wie rechtsseitig montiert werden
- ACHTUNG: nicht geeignet für gedämpfte Scharniere.

Passend für Schränke
Suitable for cabinets

40 45 50 60 cm

- Inner bin: 1 x 15 l
- **Type of installation: side-wall-mounted, with door follower**
- Automatic spring-loaded, lifted lid
- Colour: Metal parts stainless steel, Lid Aluminium, Plastic parts brown
- Product dimensions: W x D x H, 306 x 306 x 335 mm
- Packing dimensions: W x D x H, 298 x 298 x 363 mm
- Weight incl. packing: 2,5 kg
- May be installed on left or on right sidewall

Attention! Not suitable in combination with dampened door hinges

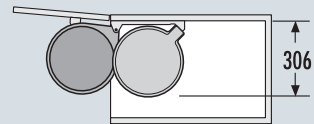
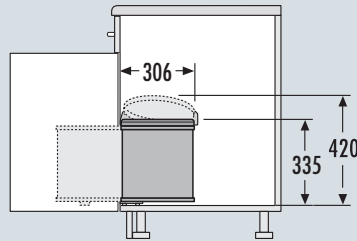

40 cm

Passend für Schränke
Suitable for cabinets

40 45 50 60 cm

- Inner bin: 1 x 20 l
- **Type of installation: side-wall-mounted, with door follower**
- Automatic spring-loaded, lifted lid
- Colour: Metal parts sheet steel white, Lid Aluminium, Plastic parts brown
- Product dimensions: W x D x H, 306 x 306 x 450 mm
- Packing dimensions: W x D x H, 295 x 295 x 431 mm
- Weight incl. packing: 2,8 kg
- May be installed on left or on right sidewall

Attention! Not suitable in combination with dampened door hinges

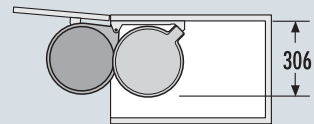
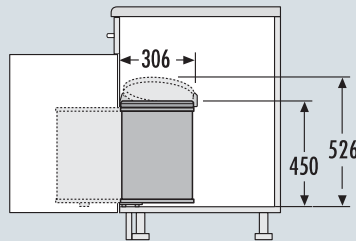

Passend für Schränke
Suitable for cabinets

40 45 50 60 cm

- Inner bin: 1 x 20 l
- **Type of installation: side-wall-mounted, with door follower**
- Automatic spring-loaded, lifted lid
- Colour: Metal parts stainless steel, Lid Aluminium, Plastic parts brown
- Product dimensions: W x D x H, 306 x 306 x 450 mm
- Packing dimensions: W x D x H, 295 x 295 x 431 mm
- Weight incl. packing: 2,8 kg
- May be installed on left or on right sidewall

Attention! Not suitable in combination with dampened door hinges

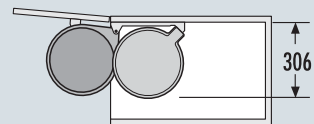
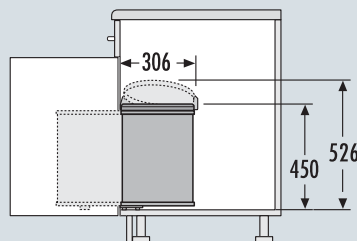

Swing



Für Schränke ab 400 mm Breite mit Drehtür
For hinged door cabinets from 400 mm width

Big Box

Hailo AS Big Box 20 silber/schwarz

3720211



- Abfalleimer: 1 x 20 l
- **Montageart: Seitenwandmontage** mit Türmitnehmer
- Automatischer Feder-Hubdeckel
- Farbe: Metallteile Stahlblech silberfarben, Kunststoffteile schwarz
- Produkt-Maße: B x T x H, 306 x 306 x 450 mm
- Verpackungsmaße: B x T x H, 295 x 295 x 431 mm
- Gewicht mit Verpackung: 2,8 kg
- Kann links- wie rechtsseitig montiert werden

ACHTUNG: nicht geeignet für gedämpfte Scharniere.

Easy Cargo

Hailo AS Easy Cargo 42

3668401



- Abfalleimer: 1 x 42 l
- **Montageart: Bodenmontage**
- Auszugsschienen: Vollauszug
- Praktische Ablagemulde im Deckel integriert
- Farbe: Metallteile silberfarben, Kunststoffteile hellgrau
- Produkt-Maße: B x T x H, 320 x 466 x 542 mm
- Verpackungsmaße: B x T x H, 345 x 510 x 560 mm
- Gewicht mit Verpackung: 8,1 kg



Easy Cargo

Hailo AS Easy Cargo 42

3668421



- Abfalleimer: 1 x 42 l
- **Montageart: Bodenmontage**
- Auszugsschienen: Vollauszug
- Beutelhalter zum Fixieren von Müllbeuteln wie zB. „Gelber Sack“
- Praktische Ablagemulde im Deckel integriert
- Farbe: Metallteile silberfarben, Kunststoffteile hellgrau
- Produkt-Maße: B x T x H, 320 x 466 x 542 mm
- Verpackungsmaße: B x T x H, 345 x 510 x 560 mm
- Gewicht mit Verpackung: 8,4 kg



Passend für Schränke
Suitable for cabinets

40

45

50

60

cm

- Inner bin: 1 x 20 l
- **Type of installation: side-wall-mounted, with door follower**
- Automatic spring-loaded, lifted lid
- Colour: Metal parts sheet steel silver-coated, Aluminium-Look-Plastic parts black
- Product dimensions: W x D x H, 306 x 306 x 450 mm
- Packing dimensions: W x D x H, 295 x 295 x 431 mm
- Weight incl. packing: 2,8 kg
- May be installed on left or on right sidewall

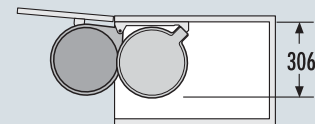
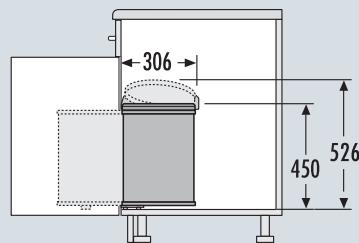

Attention! Not suitable in combination with dampened door hinges

40 cm

Passend für Schränke
Suitable for cabinets

40

45

50

60

cm

- Inner bin: 1 x 42 l
- **Type of installation: bottom-mounted**
- Slides: full extension
- Practical storage area integrated in the lid
- Colour: Metal parts silver-coloured, Plastic parts light grey
- Product dimensions: W x D x H, 320 x 466 x 542 mm
- Packing dimensions: W x D x H, 345 x 510 x 560 mm
- Weight incl. packing: 8,1 kg

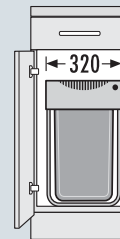
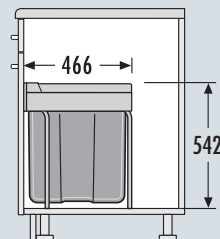

Passend für Schränke
Suitable for cabinets

40

45

50

60

cm

- Inner bin: 1 x 42 l
- **Type of installation: bottom-mounted**
- Slides: full extension
- Bagholder to fix trash bag
- Practical storage area integrated in the lid
- Colour: Metal parts silver-coloured, Plastic parts light grey
- Product dimensions: W x D x H, 320 x 466 x 542 mm
- Packing dimensions: W x D x H, 345 x 510 x 560 mm
- Weight incl. packing: 8,4 kg

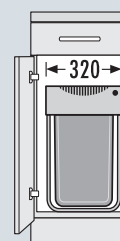
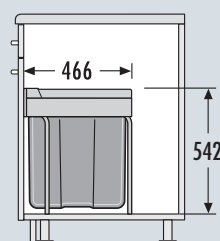

Swing



Für Schränke ab 400 mm Breite mit Drehtür
For hinged door cabinets from 400 mm width

Tandem



Hailo AS Tandem 15/15/KS hellgrau

3666801



- Trennung: 2-fach
- Abfalleimer: 2 x 15 l, Gesamtvolumen 30 l
- **Montageart: Bodenmontage**
- Auszugsschienen: Vollauszug
- Mit integriertem Kehr-Set
- Farbe: Metallteile silberfarben, Kunststoffteile hellgrau
- Produkt-Maße: B x T x H, 302 x 482 x 400 mm
- Verpackungsmaße: B x T x H, 260 x 504 x 420 mm
- Gewicht mit Verpackung: 7,8 kg



Terzett

Hailo AS Terzett 10/10/10/KS hellgrau

3666831



- Trennung: 3-fach
- Abfalleimer: 3 x 10 l, Gesamtvolumen 30 l
- **Montageart: Bodenmontage**
- Auszugsschienen: Vollauszug
- Mit integriertem Kehr-Set
- Farbe: Metallteile silberfarben, Kunststoffteile hellgrau
- Produkt-Maße: B x T x H, 302 x 482 x 400 mm
- Verpackungsmaße: B x T x H, 260 x 504 x 420 mm
- Gewicht mit Verpackung: 7,8 kg



Raumspär Tandem

Hailo AS Raumspär Tandem 18/18

3640001



- Trennung: 2-fach
- Abfalleimer: 2 x 18 l, Gesamtvolumen 36 l
- **Montageart: Bodenmontage**
- Auszugsschienen: Teilauszug
- Farbe: Metallteile silberfarben, Kunststoffteile grau/schwarz
- Produkt-Maße: B x T x H, 346 x 470 x 320 mm
- Verpackungsmaße: B x T x H, 360 x 490 x 360 mm
- Gewicht mit Verpackung: 4,8 kg



Passend für Schränke
Suitable for cabinets

40 45 50 60 cm

- Separation: 2-fold
- Inner bins: 2 x 15 l, Total capacity 30 l
- **Type of installation: bottom-mounted**
- Slides: full extension
- Equipped with a dust-pan and a brush
- Colour: Metal parts silver-coloured, Plastic parts light-grey
- Product dimensions: W x D x H, 302 x 482 x 400 mm
- Packing dimensions: W x D x H, 260 x 504 x 420 mm
- Weight incl. packing: 7,8 kg

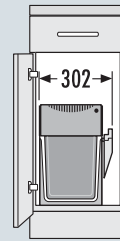
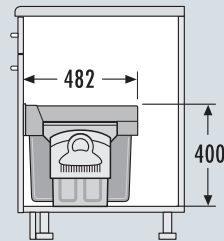

40 cm

Passend für Schränke
Suitable for cabinets

40 45 50 60 cm

- Separation: 3-fold
- Inner bins: 3 x 10 l, Total capacity 30 l
- **Type of installation: bottom-mounted**
- Slides: full extension
- Equipped with a dust-pan and a brush
- Colour: Metal parts silver-coloured, Plastic parts light-grey
- Product dimensions: W x D x H, 302 x 482 x 400 mm
- Packing dimensions: W x D x H, 260 x 504 x 420 mm
- Weight incl. packing: 7,8 kg

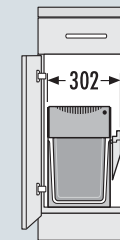
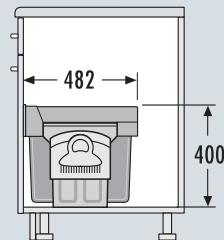

Passend für Schränke
Suitable for cabinets

40 45 50 60 cm

- Separation: 2-fold
- Inner bins: 2 x 18 l, Total capacity 36 l
- **Type of installation: bottom-mounted**
- Slides: single extension
- Colour: Metal parts silver-coloured, Plastic parts grey/black
- Product dimensions: W x D x H, 346 x 470 x 320 mm
- Packing dimensions: W x D x H, 360 x 490 x 360 mm
- Weight incl. packing: 4,8 kg

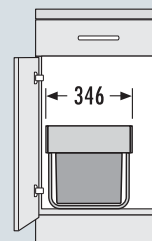
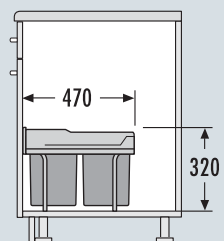

Swing



Für Schränke ab 400 mm Breite mit Drehtür
For hinged door cabinets from 400 mm width

Raumspartandem

Hailo AS Raumspartandem 18/18

3641121



- Trennung: 2-fach
- Abfalleimer: 2 x 18 l, Gesamtvolumen 36 l
- **Montageart: Bodenmontage**
- Auszugsschienen: Vollauszug
- Farbe: Metallteile silberfarben, Kunststoffteile hellgrau
- Produkt-Maße: B x T x H, 346 x 475 x 336 mm
- Verpackungsmaße: B x T x H, 360 x 490 x 370 mm
- Gewicht mit Verpackung: 5 kg



Raumspartandem

Hailo AS Raumspartandem 18/8,5/8,5/D

3642131



- Trennung: 3-fach
- Abfalleimer: 1 x 18 l, 2 x 8,5 l, Gesamtvolumen 35 l, 1 x Behälterdeckel 8,5 l
- **Montageart: Bodenmontage**
- Auszugsschienen: Vollauszug
- Farbe: Metallteile silberfarben, Kunststoffteile hellgrau
- Produkt-Maße: B x T x H, 346 x 475 x 336 mm
- Verpackungsmaße: B x T x H, 360 x 490 x 370 mm
- Gewicht mit Verpackung: 6,0 kg



Raumspartandem

Hailo AS Raumspartandem 8,5/8,5/8,5/8,5/D

3643141



- Trennung: 4-fach
- Abfalleimer: 4 x 8,5 l, Gesamtvolumen 34 l, 1 x Behälterdeckel 8,5 l
- **Montageart: Bodenmontage**
- Auszugsschienen: Vollauszug
- Farbe: Metallteile silberfarben, Kunststoffteile hellgrau
- Produkt-Maße: B x T x H, 346 x 475 x 336 mm
- Verpackungsmaße: B x T x H, 360 x 490 x 370 mm
- Gewicht mit Verpackung: 6,3 kg



Passend für Schränke
Suitable for cabinets

40

45

50

60 cm

- Separation: 2-fold
- Inner bins: 2 x 18 l, Total capacity 36 l
- **Type of installation: bottom-mounted**
- Slides: full extension
- Colour: Metal parts silver-coloured, Plastic parts light grey
- Product dimensions: W x D x H, 346 x 475 x 336 mm
- Packing dimensions: W x D x H, 360 x 490 x 370 mm
- Weight incl. packing: 5 kg

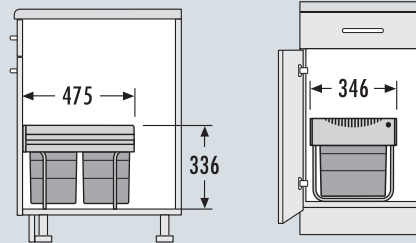

40 cm

Passend für Schränke
Suitable for cabinets

40

45

50

60 cm

- Separation: 3-fold
- Inner bins: 1 x 18 l, 2 x 8.5 l, Total capacity 35 l, 1 x Lid 8.5 l
- **Type of installation: bottom-mounted**
- Slides: full extension
- Colour: Metal parts silver-coloured, Plastic parts light grey
- Product dimensions: W x D x H, 346 x 475 x 336 mm
- Packing dimensions: W x D x H, 360 x 490 x 370 mm
- Weight incl. packing: 6,0 kg

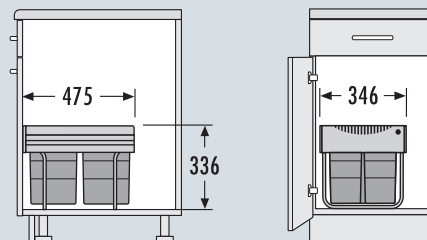

Passend für Schränke
Suitable for cabinets

40

45

50

60 cm

- Separation: 4-fold
- Inner bins: 4 x 8.5 l, Total capacity 34 l, 1 x Lid 8.5 l
- **Type of installation: bottom-mounted**
- Slides: full extension
- Colour: Metal parts silver-coloured, Plastic parts light grey
- Product dimensions: W x D x H, 346 x 475 x 336 mm
- Packing dimensions: W x D x H, 360 x 490 x 370 mm
- Weight incl. packing: 6,3 kg

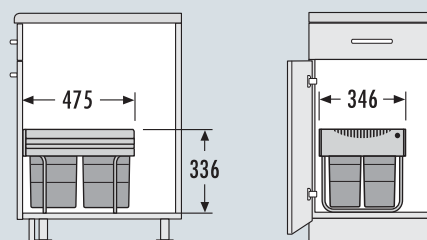

Swing



Für Schränke ab 400 mm Breite mit Drehtür
For hinged door cabinets from 400 mm width

Raumspär Tandem Comfort

Hailo AS Raumspär Tandem Comfort 20/20/KS

3641221



- Trennung: 2-fach
- Abfalleimer: 2 x 20 l, Gesamtvolumen 40 l
- **Montageart: Bodenmontage**
- Auszugsschienen: Vollauszug
- Mit integriertem Kehr-Set
- Farbe: Metallteile silberfarben, Kunststoffteile hellgrau
- Produkt-Maße: B x T x H, 346 x 475 x 392 mm
- Verpackungsmaße: B x T x H, 360 x 490 x 410 mm
- Gewicht mit Verpackung: 6 kg



Raumspär Tandem Comfort

Hailo AS Raumspär Tandem Comfort 20/10/10/D/KS

3642231



- Trennung: 3-fach
- Abfalleimer: 1 x 20 l, 2 x 10 l, Gesamtvolumen 40 l, 1 x Behälterdeckel 10 l
- **Montageart: Bodenmontage**
- Auszugsschienen: Vollauszug
- Mit integriertem Kehr-Set
- Farbe: Metallteile silberfarben, Kunststoffteile hellgrau
- Produkt-Maße: B x T x H, 346 x 475 x 392 mm
- Verpackungsmaße: B x T x H, 360 x 490 x 410 mm
- Gewicht mit Verpackung: 7 kg



Raumspär Tandem Comfort

Hailo AS Raumspär Tandem 10/10/10/10/D/KS

3643241



- Trennung: 4-fach
- Abfalleimer: 4 x 10 l, Gesamtvolumen 40 l, 1 x Behälterdeckel 10 l
- **Montageart: Bodenmontage**
- Auszugsschienen: Vollauszug
- Mit integriertem Kehr-Set
- Farbe: Metallteile silberfarben, Kunststoffteile hellgrau
- Produkt-Maße: B x T x H, 346 x 475 x 392 mm
- Verpackungsmaße: B x T x H, 360 x 490 x 410 mm
- Gewicht mit Verpackung: 7 kg



Passend für Schränke
Suitable for cabinets

40

45

50

60 cm

- Separation: 2-fold
- Inner bins: 2 x 20 l, Total capacity 40 l
- **Type of installation: bottom-mounted**
- Slides: full extension
- Equipped with a dust-pan and brush
- Colour: Metal parts silver-coloured, Plastic parts light grey
- Product dimensions: W x D x H, 346 x 475 x 392 mm
- Packing dimensions: W x D x H, 360 x 490 x 410 mm
- Weight incl. packing: 6 kg

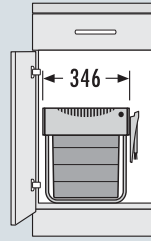
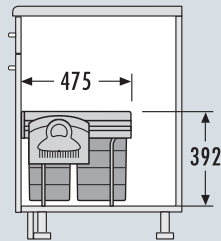

40 cm

Passend für Schränke
Suitable for cabinets

40

45

50

60 cm

- Separation: 3-fold
- Inner bins: 1 x 20 l, 2 x 10 l, Total capacity 40 l, 1 x Lid 10 l
- **Type of installation: bottom-mounted**
- Slides: full extension
- Equipped with a dust-pan and brush
- Colour: Metal parts silver-coloured, Plastic parts light grey
- Product dimensions: W x D x H, 346 x 475 x 392 mm
- Packing dimensions: W x D x H, 360 x 490 x 410 mm
- Weight incl. packing: 7 kg

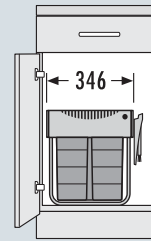
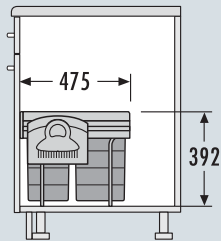

Passend für Schränke
Suitable for cabinets

40

45

50

60 cm

- Separation: 4-fold
- Inner bins: 4 x 10 l, Total capacity 40 l, 1 x Lid 10 l
- **Type of installation: bottom-mounted**
- Slides: full extension
- Equipped with a dust-pan and brush
- Colour: Metal parts silver-coloured, Plastic parts light grey
- Product dimensions: W x D x H, 346 x 475 x 392 mm
- Packing dimensions: W x D x H, 360 x 490 x 410 mm
- Weight incl. packing: 7 kg

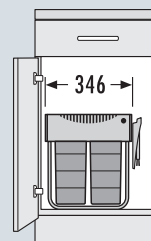
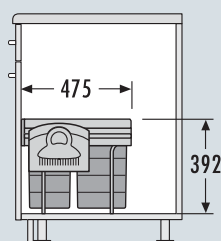

Übrigens, wussten Sie, ...

dass Hailo bereits 1993 ein Abfalltrennsystem mit Frontanbindung und Auszugschienen auf den Markt brachte und somit als Pionier dieser Systeme gilt.

By the way, did you know...

that Hailo as a pioneer launched a waste separation system with front attachment and drawer slides in 1993 ?



Slide



Für Schränke ab 400 mm Breite mit Frontauszug
For front-mount-door cabinets from 400 mm width



40 cm

Slide



Für Schränke ab 400 mm Breite mit Frontauszug For front-mount-door cabinets from 400 mm width

Cargo Soft 40



Hailo AS Cargo Soft 400 20/14

3610401



- Trennung: 2-fach
- Abfalleimer: 1 x 20 l, 1 x 14 l, Gesamtvolumen 34 l
- Montageart: Seitenwandmontage, selbstjustierend 16 - 19 mm
- **Auszugschienen: abgedeckter, gedämpfter Selbststeinzug**
- Systemtiefe: 448 mm
- Metallsystemdeckel
- Farbe: Metallteile silberfarben
- Produkt-Maße: B x T x H, 362-368 x 403 x 388 mm
- Verpackungsmaße: B x T x H, 470 x 375 x 315 mm
- Gewicht mit Verpackung: 9 kg



Euro Cargo 40 ST



Hailo AS Euro Cargo 400 ST 38/7

3619411



- Trennung: 2-fach
- Abfalleimer: 1 x 38 l, 1 x 7 l, Gesamtvolumen 45 l
- Montageart: Seitenwandmontage, selbstjustierend 16 - 19 mm
- **Auszugschienen: abgedeckter, gedämpfter Selbststeinzug mit Überauszug**
- Systemtiefe 528 mm
- Metallsystemdeckel
- Farbe: Metallteile silberfarben
- Produkt-Maße: B x T x H, 362-368 x 528 x 545 mm
- Verpackungsmaße: B x T x H, 490 x 320 x 620 mm
- Gewicht mit Verpackung: 13 kg



Bottom Mount



Hailo AS Bottom Mount 400 24/D/24/D

3616411



- Trennung: 2-fach
- Abfalleimer: 2 x 24 l, Gesamtvolumen 48 l, 2 Behälterdeckel 24 l
- Montageart: Bodenmontage
- **Auszugschienen: gedämpfter Selbststeinzug**
- Systemtiefe 530 mm
- Farbe: Metallteile silberfarben, Kunststoffteile hellgrau
- Produkt-Maße: B x T x H, 350 x 530 x 385 mm
- Verpackungsmaße: B x T x H, 365 x 355 x 585 mm
- Gewicht mit Verpackung: 9,9 kg



- Separation: 2-fold
- Inner bins: 1 x 20 l, 1 x 14 l, Total capacity 34 l
- Type of installation: side-wall-mounted, self-adjusting to 16 - 19 mm side walls
- Slides: covered, dampened slides with self-closing device
- System-depth: 448 mm
- Sheet metal system Lid
- Colour: Frame metal parts silver-coloured
- Product dimensions: W x D x H, 362-368 x 403 x 388 mm
- Packing dimensions: W x D x H, 470 x 375 x 315 mm
- Weight incl. packing: 9 kg

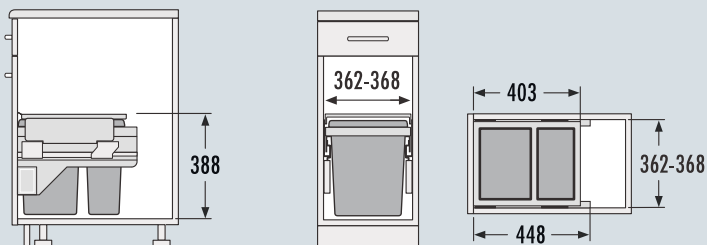

- Separation: 2-fold
- Inner bins: 1 x 38 l, 1 x 7 l, Total capacity 45 l
- Type of installation: side-wall-mounted, self-adjusting to 16 - 19 mm side walls
- Slides: covered, dampened slides with self-closing device with over-travel
- System-depth 528 mm
- Sheet metal system Lid
- Colour: Frame metal parts silver-coloured
- Product dimensions: W x D x H, 362-368 x 528 x 545 mm
- Packing dimensions: W x D x H, 490 x 320 x 620 mm
- Weight incl. packing 13 kg

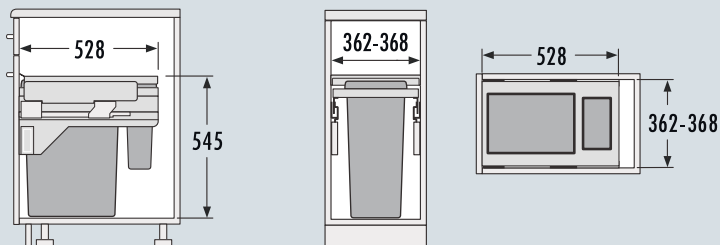

- Separation: 2-fold
- Inner bins: 2 x 24 l, Total capacity 48 l
2 x Lid 24 l
- Type of installation: bottom-mounted
- Slides: dampened slides with self-closing device
- System-depth 530 mm
- Colour: Frame sheet steel silver-coloured, Plastic parts light grey
- Product dimensions: W x D x H, 350 x 530 x 385mm
- Packing dimensions: W x D x H, 365 x 355 x 585 mm
- Weight incl. packing: 9,9 kg

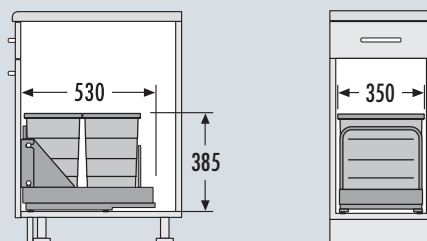

Slide



Für Schränke ab 400 mm Breite mit Frontauszug
For front-mount-door cabinets from 400 mm width
and minimum 800 mm double-door sink cabinets

Bottom Mount



Hailo AS Bottom Mount 400 29/D/29/D

3616401



- Trennung: 2-fach
- Abfalleimer: 2 x 29 l, Gesamtvolumen 58 l
2 Behälterdeckel 29 l
- Montageart: Bodenmontage
- Auszugsschienen: gedämpfter Selbststeinzug
- Systemtiefe 530 mm
- Farbe: Metallteile silberfarben, Kunststoffteile hellgrau
- Produkt-Maße: B x T x H, 350 x 530 x 523 mm
- Verpackungsmaße: B x T x H, 365 x 355 x 585 mm
- Gewicht mit Verpackung: 12 kg



- Separation: 2-fold
- Inner bins: 2 x 29 l, Total capacity 58 l, 2 x Lid 29 l
- Type of installation: bottom-mounted
- Slides: **dampened slides with self-closing device**
- System-depth 530 mm
- Colour: Frame sheet steel silver-coloured,
Plastic parts light grey
- Product dimensions: W x D x H, 350 x 530 x 523 mm
- Packing dimensions: W x D x H, 365 x 355 x 585 mm
- Weight incl. packing: 12 kg

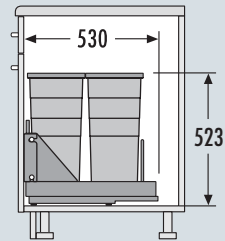

40 cm



Übrigens, wussten Sie, ...

dass Hailo Einbau-Abfallsammler
ausnahmslos in Deutschland
hergestellt werden?

By the way, did you know...

that Hailo built-in waste
separation systems are exclusively
manufactured in Germany?

Swing

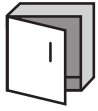

Für Schränke ab 450 mm Breite mit Drehtür
For hinged door cabinets from 450 mm width



45 cm

Swing



Für Schränke ab 450 mm Breite mit Drehtür
For hinged door cabinets from 450 mm width

Bottom Mount



Hailo AS Bottom Mount 450 29/D/29/D

3616451



- Trennung: 2-fach
- Abfalleimer: 2 x 29 l, Gesamtvolumen 58 l
2 Behälterdeckel 29 l
- **Montageart: Bodenmontage**
- Auszugsschienen: gedämpfter Selbsteinzug
- Systemtiefe 530 mm
- Farbe: Metallteile silberfarben, Kunststoffteile hellgrau
- Produkt-Maße: B x T x H, 350 x 530 x 523 mm
- Verpackungsmaße: B x T x H, 365 x 355 x 585 mm
- Gewicht mit Verpackung: 10 kg



Bottom Mount



Hailo AS Bottom Mount 450 24/D/24/D

3616461



- Trennung: 2-fach
- Abfalleimer: 2 x 24 l, Gesamtvolumen 48 l
2 Behälterdeckel 24 l
- **Montageart: Bodenmontage**
- Auszugsschienen: gedämpfter Selbsteinzug
- Systemtiefe 530 mm
- Farbe: Metallteile silberfarben, Kunststoffteile hellgrau
- Produkt-Maße: B x T x H, 350 x 530 x 385 mm
- Verpackungsmaße: B x T x H, 365 x 355 x 585 mm
- Gewicht mit Verpackung: 9,1 kg



Passend für Schränke
Suitable for cabinets

45 50 60 cm

- Separation: 2-fold
- Inner bins: 2 x 29 l, Total capacity 58 l, 2 x Lid 24 l
- **Type of installation: bottom-mounted**
- Slides: dampened slides with self-closing device
- System-depth 530 mm
- Colour: Frame sheet steel silver-coloured, Plastic parts light grey
- Product dimensions: W x D x H, 350 x 530 x 523 mm
- Packing dimensions: W x D x H, 365 x 355 x 585 mm
- Weight incl. packing: 10 kg

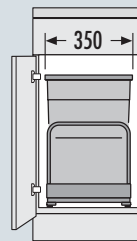
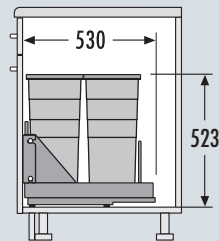

45 cm

Passend für Schränke
Suitable for cabinets

45 50 60 cm

- Separation: 2-fold
- Inner bins: 2 x 24 l, Total capacity 48 l, 2 x Lid 24 l
- **Type of installation: bottom-mounted**
- Slides: dampened slides with self-closing device
- System-depth 530 mm
- Colour: Frame sheet steel silver-coloured, Plastic parts light grey
- Product dimensions: W x D x H, 350 x 530 x 385 mm
- Packing dimensions: W x D x H, 365 x 355 x 585 mm
- Weight incl. packing: 9,1kg

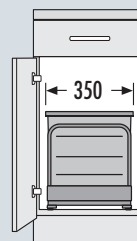
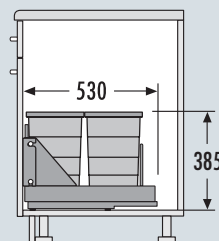

Swing



Für Schränke ab 450 mm Breite mit Drehtür
For hinged door cabinets from 450 mm width

Uno

Hailo AS Uno 18 weiß

3418001



- Abfalleimer: 1 x 18 l
- **Montageart: Seitenwandmontage** mit Türmitnehmer
- Automatischer Dreh-Kipp-Deckel
- Farbe: Metallteile weiß, Kunststoffteile weiß
- Produkt-Maße: B x T x H, 388 x 203 x 420 mm
- Verpackungsmaße: B x T x H, 395 x 206 x 405 mm
- Gewicht mit Verpackung: 3,1 kg
- Kann links- wie rechtsseitig montiert werden

Uno

Hailo AS Uno 18 Edelstahl/schwarz

3418101



- Abfalleimer: 1 x 18 l
- **Montageart: Seitenwandmontage** mit Türmitnehmer
- Automatischer Dreh-Kipp-Deckel
- Farbe: Metallteile Edelstahl, Kunststoffteile schwarz
- Produkt-Maße: B x T x H, 388 x 203 x 420 mm
- Verpackungsmaße: B x T x H, 395 x 206 x 405 mm
- Gewicht mit Verpackung: 3,1 kg
- Kann links- wie rechtsseitig montiert werden

Uno

Hailo AS Uno 18 Edelstahl/weiß

3418901



- Abfalleimer: 1 x 18 l
- **Montageart: Seitenwandmontage** mit Türmitnehmer
- Automatischer Dreh-Kipp-Deckel
- Farbe: Metallteile Edelstahl, Kunststoffteile weiß
- Produkt-Maße: B x T x H, 388 x 203 x 420 mm
- Verpackungsmaße: B x T x H, 395 x 206 x 405 mm
- Gewicht mit Verpackung: 3,1 kg
- Kann links- wie rechtsseitig montiert werden

Passend für Schränke
Suitable for cabinets

45 50 60 cm

- Inner bin: 1 x 18 l
- **Type of installation:** side-wall-mounted, with door follower
- Lid with turn & tilt mechanism
- Colour: Metal parts white, Plastic parts white
- Product dimensions: W x D x H, 388 x 203 x 420 mm
- Packing dimensions: W x D x H, 395 x 206 x 405 mm
- Weight incl. packing: 3,1 kg
- May be installed on left or on right sidewall

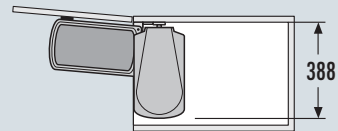
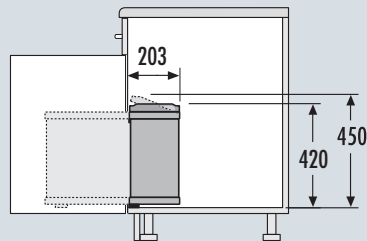

45 cm

Passend für Schränke
Suitable for cabinets

45 50 60 cm

- Inner bin: 1 x 18 l
- **Type of installation:** side-wall-mounted, with door follower
- Lid with turn & tilt mechanism
- Colour: Metal parts stainless steel, Plastic parts black
- Product dimensions: W x D x H, 388 x 203 x 420 mm
- Packing dimensions: W x D x H, 395 x 206 x 405 mm
- Weight incl. packing: 3,1 kg
- May be installed on left or on right sidewall

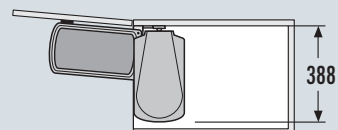
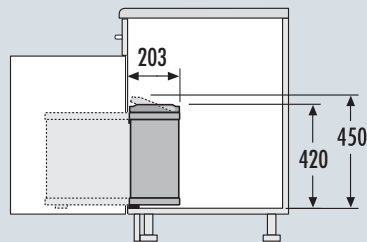

Passend für Schränke
Suitable for cabinets

45 50 60 cm

- Inner bin: 1 x 18 l
- **Type of installation:** side-wall-mounted, with door follower
- Lid with turn & tilt mechanism
- Colour: Metal parts stainless steel, Plastic parts white
- Product dimensions: W x D x H, 388 x 203 x 420 mm
- Packing dimensions: W x D x H, 395 x 206 x 405 mm
- Weight incl. packing: 3,1 kg
- May be installed on left or on right sidewall

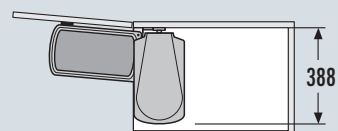
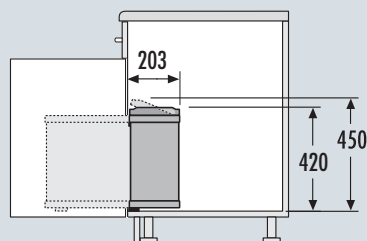

Swing



Für Schränke ab 450 mm Breite mit Drehtür
For hinged door cabinets from 450 mm width

Duo

Hailo AS Duo 8/8 weiß

3416001



- Trennung: 2-fach
- Abfalleimer: 2 x 8 l, Gesamtvolumen 16 l
- **Montageart: Seitenwandmontage** mit Türmitnehmer
- Automatischer Dreh-Kipp-Deckel
- Farbe: Metallteile weiß, Kunststoffteile weiß
- Produkt-Maße: B x T x H, 388 x 203 x 420 mm
- Verpackungsmaße: B x T x H, 395 x 206 x 405 mm
- Gewicht mit Verpackung: 4,2 kg
- Kann links- wie rechtsseitig montiert werden

Duo

Hailo AS Duo 8/8 Edelstahl/schwarz

3416101



- Trennung: 2-fach
- Abfalleimer: 2 x 8 l braun, Gesamtvolumen 16 l
- **Montageart: Seitenwandmontage** mit Türmitnehmer
- Automatischer Dreh-Kipp-Deckel
- Farbe: Metallteile Edelstahl, Kunststoffteile schwarz
- Produkt-Maße: B x T x H, 388 x 203 x 420 mm
- Verpackungsmaße: B x T x H, 395 x 206 x 405 mm
- Gewicht mit Verpackung: 4,2 kg
- Kann links- wie rechtsseitig montiert werden

Duo

Hailo AS Duo 8/8 Edelstahl/weiß

3416901



- Trennung: 2-fach
- Abfalleimer: 2 x 8 l, Gesamtvolumen 16 l
- **Montageart: Seitenwandmontage** mit Türmitnehmer
- Automatischer Dreh-Kipp-Deckel
- Farbe: Metallteile Edelstahl, Kunststoffteile weiß
- Produkt-Maße: B x T x H, 388 x 203 x 420 mm
- Verpackungsmaße: B x T x H, 395 x 206 x 405 mm
- Gewicht mit Verpackung: 4,2 kg
- Kann links- wie rechtsseitig montiert werden

Passend für Schränke
Suitable for cabinets

45 50 60 cm

- Separation: 2-fold
- Inner bins: 2 x 8 l, Total capacity 16 l
- **Type of installation: side-wall-mounted, with door follower**
- Lid with turn & tilt mechanism
- Colour: Metal parts white, Plastic parts white
- Product dimensions: W x D x H, 388 x 203 x 420 mm
- Packing dimensions: W x D x H, 395 x 206 x 405 mm
- Weight incl. packing: 4,2 kg
- May be installed on left or on right sidewall

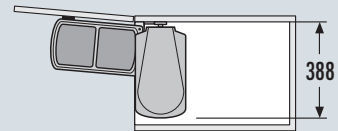
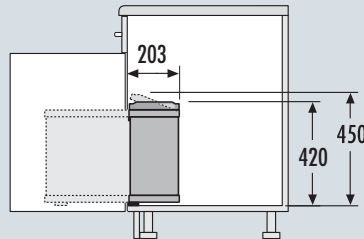

45 cm

Passend für Schränke
Suitable for cabinets

45 50 60 cm

- Separation: 2-fold
- Inner bins: 2 x 8 l, Total capacity 16 l
- **Type of installation: side-wall-mounted, with door follower**
- Lid with turn & tilt mechanism
- Colour: Metal parts stainless steel, Plastic parts black
- Product dimensions: W x D x H, 388 x 203 x 420 mm
- Packing dimensions: W x D x H, 395 x 206 x 405 mm
- Weight incl. packing: 4,2 kg
- May be installed on left or on right sidewall

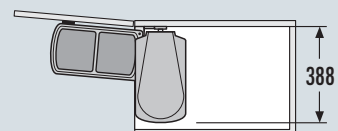
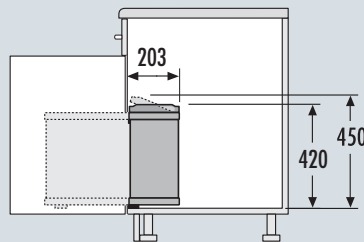

Passend für Schränke
Suitable for cabinets

45 50 60 cm

- Separation: 2-fold
- Inner bins: 2 x 8 l, Total capacity 16 l
- **Type of installation: side-wall-mounted, with door follower**
- Lid with turn & tilt mechanism
- Colour: Metal parts stainless steel, Plastic parts white
- Product dimensions: W x D x H, 388 x 203 x 420 mm
- Packing dimensions: W x D x H, 395 x 206 x 405 mm
- Weight incl. packing: 4,2 kg
- May be installed on left or on right sidewall

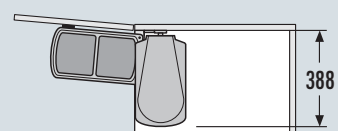
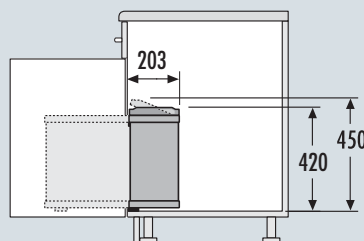

Swing



Für Schränke ab 450 mm Breite mit Drehtür
For hinged door cabinets from 450 mm width

Pico Huckepack

Hailo AS Pico Huckepack 5 weiß

3405001



- Abfalleimer: 1 x 5 l
- **Anbau an: Uno 3418 und Duo 3416**
- Farbe: Kunststoffteile weiß
- Produkt-Maße: B x T x H, 175 x 175 x 310 mm
- Verpackungsmaße: B x T x H, 185 x 185 x 290 mm
- Gewicht mit Verpackung: 0,5 kg

Pico Huckepack

Hailo AS Pico Huckepack 5 schwarz

3405101



- Abfalleimer: 1 x 5 l
- **Anbau an: Uno 3418 und Duo 3416**
- Farbe: Kunststoffteile schwarz
- Produkt-Maße: B x T x H, 175 x 175 x 310 mm
- Verpackungsmaße: B x T x H, 185 x 185 x 290 mm
- Gewicht mit Verpackung: 0,5 kg

Passend für Schränke
Suitable for cabinets

45 50 60 cm

- Inner bin: 1 x 5 l
- **Attachment onto Uno 3418 and Duo 3416**
- Colour: Plastic parts white
- Product dimensions: W x D x H, 175 x 175 x 310 mm
- Packing dimensions: W x D x H, 185 x 185 x 290 mm
- Weight incl. packing: 0,5 kg

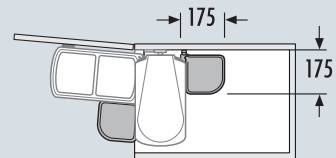
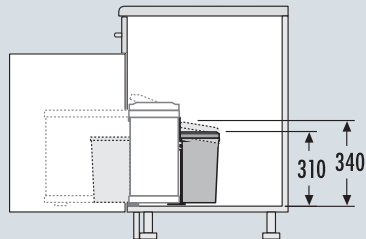

45 cm

Passend für Schränke
Suitable for cabinets

45 50 60 cm

- Inner bin: 1 x 5 l
- **Attachment onto Uno 3418 and Duo 3416**
- Colour: Plastic parts black
- Product dimensions: W x D x H, 175 x 175 x 310 mm
- Packing dimensions: W x D x H, 185 x 185 x 290 mm
- Weight incl. packing: 0,5 kg

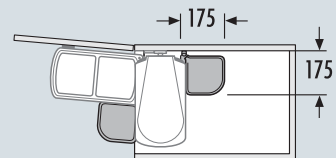
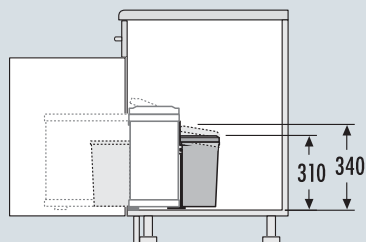



Übrigens, wussten Sie, ...

dass Hailo Einbautechnik Produkte mit über 100.000 Auszugszyklen getestet werden, bevor sie auf den Markt kommen?

By the way, did you know...

that Hailo Built-In Technology Products are tested on more than 100,000 pull-out cycles before they reach the market?

Slide



Für Schränke mit 450 mm Breite mit Frontauszug
For cabinets with front-mounted door of 450 mm width



45 cm

Slide



Für Schränke mit 450 mm Breite mit Frontauszug
For cabinets with front-mounted door of 450 mm width

Cargo Synchro



Hailo AS Cargo Synchro 450 18/18

3608471



- Trennung: 2-fach
- Abfalleimer: 2 x 18 l, Gesamtvolumen 36 l
- Montageart: Seitenwandmontage, selbstjustierend 16 - 19 mm
- **Auszugsschienen: abgedeckter, gedämpfter Selbststeinzug mit synchronisiertem Überauszug**
- Systemtiefe: 400 mm
- Herausfahrbare Systemdeckel aus Metall/Kunststoff, vollflächig belegt mit rutschfester Gummimatte
- Farbe: Metall- und Kunststoffteile slate-grey
- Produkt-Maße: B x T x H, 412-418 x 400 x 424 mm
- Verpackungsmaße: B x T x H, 555 x 280 x 490 mm
- Gewicht mit Verpackung: 10,2 kg

Cargo Synchro



Hailo AS Cargo Synchro 450 55

3608461



- Abfalleimer: 1 x 55 l
- Montageart: Seitenwandmontage, selbstjustierend 16 - 19 mm
- **Auszugsschienen: abgedeckter, gedämpfter Selbststeinzug mit synchronisiertem Überauszug**
- Systemtiefe: 400 mm
- Herausfahrbare Systemdeckel aus Metall/Kunststoff, vollflächig belegt mit rutschfester Gummimatte
- Farbe: Metall- und Kunststoffteile slate-grey
- Produkt-Maße: B x T x H, 412-418 x 400 x 544 mm
- Verpackungsmaße: B x T x H, 485 x 445 x 530 mm
- Gewicht mit Verpackung: 10,5 kg

Euro Cargo 45

Hailo AS Euro Cargo 450 38/38

3619451



- Trennung: 2-fach
- Abfalleimer: 2 x 38 l, Gesamtvolumen 76 l
- Montageart: Seitenwandmontage, selbstjustierend 16 - 19 mm
- **Auszugsschienen: abgedeckter Überauszug**
- Systemtiefe: 528 mm
- Metallsystemdeckel
- Farbe: Metallteile Stahlblech silberfarben
- Produkt-Maße: B x T x H, 412-418 x 528 x 545 mm
- Verpackungsmaße: B x T x H, 490 x 320 x 620 mm
- Gewicht mit Verpackung: 12,4 kg

- Separation: 2-fold
- Inner bins: 2 x 18 l, Total capacity 36 l
- Type of installation: side-wall-mounted, self-adjusting to 16 - 19 mm side walls
- Slides: covered, dampened slides with self-closing device with fully synchronized over-travel
- System-depth: 400 mm
- Pullout metal/plastic system lid, with anti-slip rubber mat
- Colour: Metal parts powder coated slate-grey, plastic parts slate-grey
- Product dimensions: W x D x H, 412-418 x 400 x 424 mm
- Packing dimensions: W x D x H, 555 x 280 x 490 mm
- Weight incl. packing: 10,2 kg

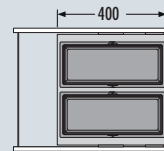
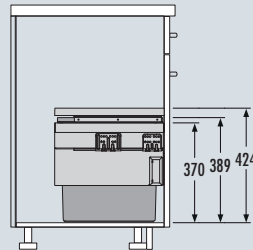

- Inner bin: 1 x 55 l
- Type of installation: side-wall-mounted, self-adjusting to 16 - 19 mm side walls
- Slides: covered, dampened slides with self-closing device with fully synchronized over-travel
- System-depth: 400 mm
- Pullout metal/plastic system lid, with anti-slip rubber mat
- Colour: Metal parts powder coated slate-grey, plastic parts slate-grey
- Product dimensions: W x D x H, 412-418 x 400 x 544 mm
- Packing dimensions: W x D x H, 485 x 445 x 530 mm
- Weight incl. packing: 10,5 kg

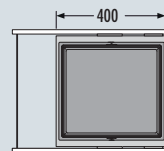
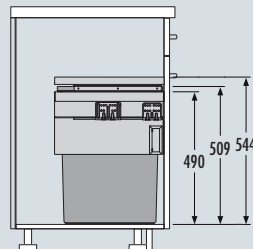

- Separation: 2-fold
- Inner bins: 2 x 38 l, Total capacity 76 l
- Type of installation: side-wall-mounted, self-adjusting to 16 - 19 mm side walls
- Slides: covered, non-dampened over travel slides
- System-depth 528 mm
- Sheet metal system Lid
- Colour: Metal parts sheet steel silver-coloured
- Product dimensions: W x D x H, 412-418 x 528 x 545 mm
- Packing dimensions: W x D x H, 490 x 320 x 620 mm
- Weight incl. packing: 12,4 kg

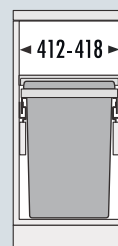
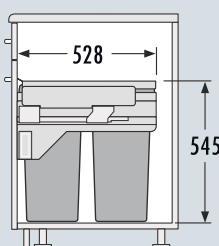

45 cm

Slide



Für Schränke mit 450 mm Breite mit Frontauszug
For cabinets with front-mounted door of 450 mm width

Euro Cargo 45 ST



Hailo AS Euro Cargo 450 ST 38/38



3619461

- Trennung: 2-fach
- Abfalleimer: 2 x 38 l, Gesamtvolumen 76 l
- Montageart: Seitenwandmontage, selbstjustierend 16 - 19 mm
- **Auszugsschienen: abgedeckter, gedämpfter Selbsteinzug mit Überauszug**
- Systemtiefe: 528 mm
- Metallsystemdeckel
- Farbe: Metallteile Stahlblech silberfarben
- Produkt-Maße: B x T x H, 412-418 x 528 x 545 mm
- Verpackungsmaße: B x T x H, 490 x 320 x 620 mm
- Gewicht mit Verpackung: 12,4 kg



Euro Cargo S



Hailo AS Euro Cargo S 450 19/19



3610471

- Trennung: 2-fach
- Abfalleimer: 2 x 19 l, Gesamtvolumen 38 l
- Montageart: Seitenwandmontage, selbstjustierend 16 - 19 mm
- **Auszugsschiene: abgedeckter, gedämpfter Selbsteinzug**
- Systemtiefe: 448 mm
- Metallsystemdeckel
- Farbe: Metallteile Stahlblech silberfarben
- Produkt-Maße: B x T x H, 412-418 x 403 x 439 mm
- Verpackungsmaße: B x T x H, 510 x 260 x 420 mm
- Gewicht mit Verpackung: 10,8 kg

Cargo Soft



Hailo AS Cargo Soft 450 10/10/10/D/U



3610491

- Trennung: 3-fach
- Abfalleimer: 3 x 10 l, Gesamtvolumen 30 l,
1 x Behälterdeckel 10 l, 1 x Utensiliendepot
- Montageart: Seitenwandmontage, selbstjustierend 16 - 19 mm
- **Auszugsschiene: abgedeckter, gedämpfter Selbsteinzug**
- Systemtiefe: 448 mm
- Metallsystemdeckel
- Farbe: Metallteile Stahlblech silberfarben
- Produkt-Maße: B x T x H, 412-418 x 403 x 388 mm
- Verpackungsmaße: B x T x H, 510 x 260 x 420 mm
- Gewicht mit Verpackung: 10,2 kg



- Separation: 2-fold
- Inner bins: 2 x 38 l, Total capacity 76 l
- Type of installation: side-wall-mounted, self-adjusting to 16 - 19 mm side walls
- **Slides: covered, dampened slides with self-closing device with over-travel**
- System-depth 528 mm
- Sheet metal system Lid
- Colour: Metal parts sheet steel silver-coloured
- Product dimensions: W x D x H, 412-418 x 528 x 545 mm
- Packing dimensions: W x D x H, 490 x 320 x 620 mm
- Weight incl. packing: 12,4 kg

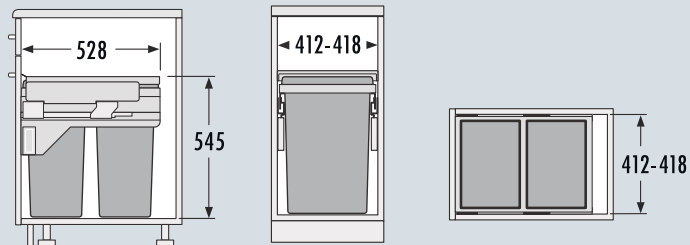

- Separation: 2-fold
- Inner bins: 2 x 19 l, Total capacity 38 l
- Type of installation: side-wall-mounted, self-adjusting to 16 - 19 mm side walls
- **Slides: covered, dampened slides with self-closing device**
- System-depth: 448 mm
- Sheet metal system Lid
- Colour: Metal parts sheet steel silver-coloured
- Product dimensions: W x D x H, 412-418 x 403 x 439 mm
- Packing dimensions: W x D x H, 510 x 260 x 420 mm
- Weight incl. packing: 10,8 kg

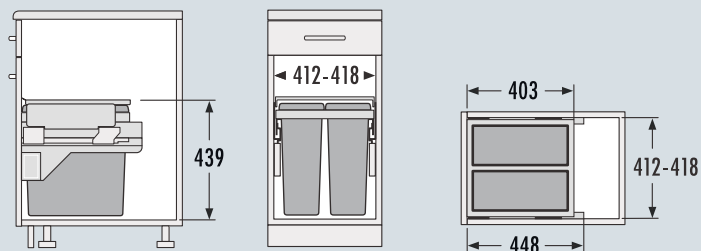

- Separation: 3-fold
- Inner bins: 3 x 10 l, Total capacity 30 l, 1 x Lid 10 l, 1 x utensil depot
- Type of installation: side-wall-mounted, self-adjusting to 16 - 19 mm side walls
- **Slides: covered, dampened slides with self-closing device**
- System-depth: 448 mm
- Sheet metal system Lid
- Colour: Metal parts sheet steel silver-coloured
- Product dimensions: W x D x H, 412-418 x 403 x 388 mm
- Packing dimensions: W x D x H, 510 x 260 x 420 mm
- Weight incl. packing: 10,2 kg

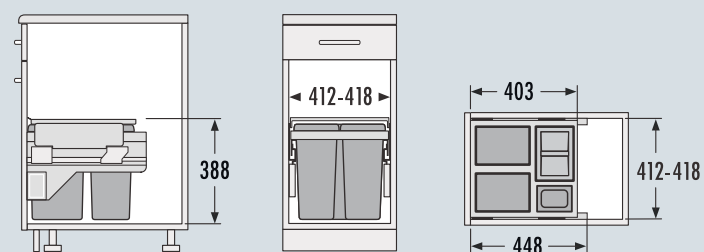

45 cm

Slide



Für Schränke mit 450 mm Breite mit Frontauszug For cabinets with front-mounted door of 450 mm width

Cargo Soft kurz short



Hailo AS Cargo Soft short 450 14/14

3610481



- Trennung: 2-fach
- Abfalleimer: 2 x 14 l, Gesamtvolumen 28 l
- Montageart: Seitenwandmontage, selbstjustierend 16 - 19 mm
- **Auszugsschiene: abgedeckter, gedämpfter Selbsteinzug**
- Systemtiefe: 448 mm
- Metallsystemdeckel
- Farbe: Metallteile Stahlblech silberfarben
- Produkt-Maße: B x T x H, 412-418 x 332 x 370 mm
- Verpackungsmaße: B x T x H, 510 x 260 x 420 mm
- Gewicht mit Verpackung: 11 kg

Cargo Basic

Hailo AS Cargo Basic 450 10/10/10/D/U

3609451



- Trennung: 3-fach
- Abfalleimer: 3 x 10 l, Gesamtvolumen 30 l,
1 x Behälterdeckel 10 l, 1 x Utensiliendepot
- Montageart: Seitenwandmontage, selbstjustierend 16 - 19 mm
- **Auszugsschienen: Überauszug mit Selbsteinzug**
- Systemtiefe: 403 mm
- Metallsystemdeckel
- Farbe: Metallteile silberfarben
- Produkt-Maße: B x T x H, 412-418 x 403 x 387 mm
- Verpackungsmaße: B x T x H, 510 x 260 x 420 mm
- Gewicht mit Verpackung: 10 kg



- Separation: 2-fold
- Inner bins: 2 x 14 l, Total capacity 28 l
- Type of installation: side-wall-mounted, self-adjusting to 16 - 19 mm side walls, mounts also under sink
- Slides: **covered, dampened slides with self-closing device**
- System-depth: 448 mm
- Sheet metal system Lid
- Colour: Metal parts sheet steel silver-coloured
- Product dimensions: W x D x H, 412-418 x 332 x 370 mm
- Packing dimensions: W x D x H, 510 x 260 x 420 mm
- Weight incl. packing: 11 kg

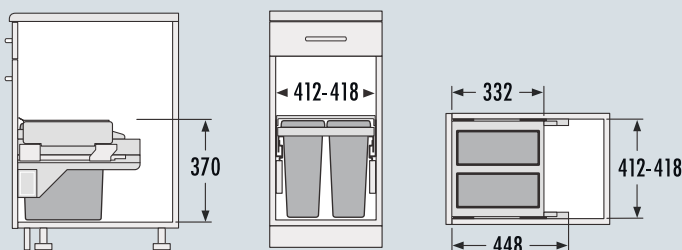

45 cm

- Separation: 3-fold
- Inner bins: 3 x 10 l, Total capacity 30 l
1 x Lid 10 l, 1 x utensil depot
- Type of installation: side-wall-mounted, self-adjusting to 16 - 19 mm side walls
- Slides: **non-dampened over travel slides**
- System-depth: 403 mm
- Sheet metal system Lid
- Colour: Metal parts silver-coloured
- Product dimensions: W x D x H, 412-418 x 403 x 387 mm
- Packing dimensions: W x D x H, 510 x 260 x 420 mm
- Weight incl. packing: 10 kg

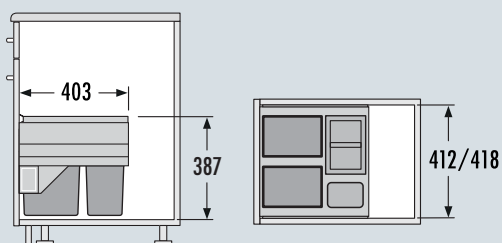

Slide



Für Schränke mit 450 mm Breite mit Frontauszug
For cabinets with front-mounted door of 450 mm width

Hailo Kick and Go

Fußhebel

3691301

3691401

3691501



3691301 Fußhebel "Kick and go" für unteren Schubkasten
3691401 Fußhebel "Kick and go" für Cargo Basic, 3609
3691501 Fußhebel "Kick and go"
für Euro Cargo 3614 und 3619- 451+601

Die Cargos fahren per Fußdruck heraus

Mehr Infos auf Seite 202

Hailo Libero

Türöffner

3697101



Hailo Libero – Hands Free Opener

Die Öffnungsunterstützung von Hailo für ein automatisches, komfortables Öffnen aller Abfalltrennsysteme mit Frontanbindung und aller Auszugssysteme.

Ausführliche Beschreibung Seite 198

Kann in Verbindung mit Metalltüren, gerahmten Metalltüren und Metall-Sockeln zu Funktionsstörungen führen.

Hailo Libero 2.0

Türöffner

3697201



Hailo Libero – Hands Free Opener

Die Öffnungsunterstützung von Hailo für ein automatisches, komfortables Öffnen aller Abfalltrennsysteme mit Frontanbindung und aller Auszugssysteme.

Ausführliche Beschreibung Seite 200

Foot Pedal

3691301 Foot Pedal "Kick and go" for lower drawer
 3691401 Foot Pedal "Kick and go" for Cargo Basic
 3691501 Foot Pedal "Kick and go" for Euro Cargo 45
 & Euro Cargo 60

The Cargo leaves the cabinet by
 a light toe-kick – hands- free

More information page 202

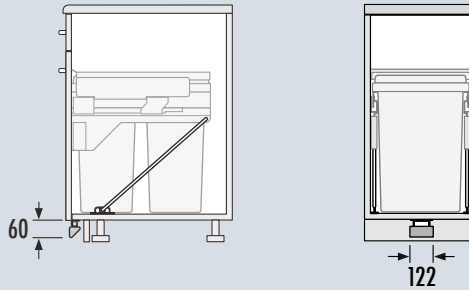

45 cm

Door Opener

Hailo „Libero“ – Hands Free Opener

Hailo's electronic front-mount-door and drawer–
 opener „Libero“ offers an automatic, comfortable hands-free
 opening of all waste-recycling-systems with attached
 door-panel and of any common, also damped,
 drawer-mounted systems.

With 2-pin Euro-Plug, 230 V, IP 4.1 certified

More information page 198

If installed behind a door-panel with a metal frame,
 or behind a metal cabinet-front, or above a metal plinth,
 malfunctions may occur.

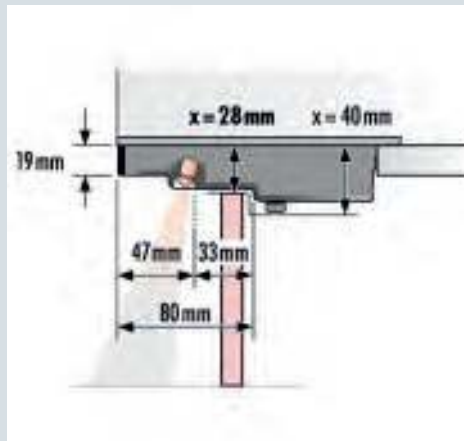

Door Opener

Hailo „Libero“ – Hands Free Opener

Hailo's electronic front-mount-door and drawer–
 opener „Libero“ offers an automatic, comfortable hands-free
 opening of all waste-recycling-systems with attached door-panel
 and of any common, also damped, drawer-mounted systems.
 With 2-pin Euro-Plug, 230 V, IP 4.1 certified

More information: page 200





Übrigens, wussten Sie, ...

dass Hailo im Verzeichnis „Marken des Jahrhunderts“ neben anderen 300 Premiummarken vertreten ist?

By the way, did you know...

that Hailo is amongst 300 premium brands listed in the “Brands of the Century” guide?

Inset



Einsatz für Schränke ab 450 mm Breite mit Frontauszug
For cabinets with pull-out shelf from 450 mm width



45 cm

Inset



Einsatz für Schränke mit 450 mm Breite mit Frontauszug For cabinets with pull-out shelf from 450 mm width

Triple XL 45

Hailo AS Triple XL 450 19/19



- Trennung: 2-fach
- Abfalleimer: 2 x 19 l, Gesamtvolumen 38 l
- **Montageart: Schubkastenmontage**, Seitenwandstärke 16 - 19 mm
- Schubkasten Nenntiefe \geq 420 mm
- Metall-Systemdeckel
- Farbe: Metallteile silberfarben
- Produkt-Maße: T x H, 400 x 430 mm
- Verpackungsmaße: B x T x H, 435 x 230 x 510 mm
- Gewicht mit Verpackung: 8,9 kg

Triple XL 45

Hailo AS Triple XL 450 10/10/10/D/U



- Trennung: 3-fach
- Abfalleimer: 3 x 10 l, Gesamtvolumen 30 l,
1 x Behälterdeckel 10 l, 1 x Utensiliendepot
- **Montageart: Schubkastenmontage**, Seitenwandstärke 16 - 19 mm
- Schubkasten Nenntiefe \geq 420 mm
- Metall-Systemdeckel
- Farbe: Metallteile silberfarben
- Produkt-Maße: T x H, 400 x 378 mm
- Verpackungsmaße: B x T x H, 435 x 230 x 510 mm
- Gewicht mit Verpackung: 8,5 kg



XXL 45

Hailo AS XXL 450 18/D/12/P/U



- Trennung: 2-fach
- Abfalleimer: 1 x 18 l, 1 x 12 l, Gesamtvolumen 30 l,
1 x Putzmittelkorb 4,1 l, 1 x Behälterdeckel 18 l, 1 x Utensiliendepot
- **Montageart: Schubkastenmontage**, Seitenwandstärke 16 - 19 mm
- Schubkasten Nenntiefe \geq 450 mm
- Metall-Systemdeckel
- Farbe: Metallteile silberfarben
- Produkt-Maße: T x H, 433 x 330 mm
- Verpackungsmaße: B x T x H, 425 x 315 x 455 mm
- Gewicht mit Verpackung: 8,1 kg





Hohe Variante
Tall Type

- Separation: 2-fold
- Inner bins: 2 x 19 l, Total capacity 38 l
- **Type of installation: inside available drawer,** side-wall-thickness 16 - 19 mm
- Nominal drawer-depth \geq 420 mm
- Sheet metal system Lid
- Colour: Metal parts silver-coloured
- Product dimensions: D x H, 400 x 430 mm
- Packing dimensions: W x D x H, 435 x 230 x 510 mm
- Weight incl. packing: 8,9 kg

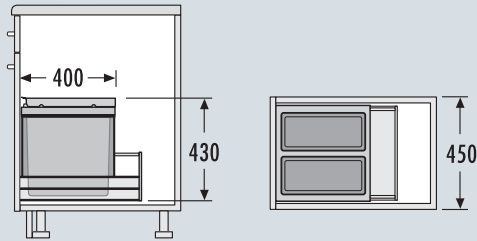

45 cm



Mittlere Variante
Medium Type

- Separation: 3-fold
- Inner bins: 3 x 10 l, Total capacity 30 l
1 x Lid 10 l, 1 x utensil depot
- **Type of installation: inside available drawer,** side-wall-thickness 16 - 19 mm
- Nominal drawer-depth \geq 420 mm
- Sheet metal system Lid
- Colour: Metal parts silver-coloured
- Product dimensions: D x H, 400 x 378 mm
- Packing dimensions: W x D x H, 435 x 230 x 510 mm
- Weight incl. packing: 8,5 kg

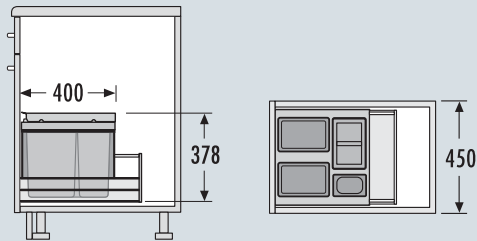

Niedrige Variante
Low Type

- Separation: 2-fold
- Inner bins: 1 x 18 l, 1 x 12 l, Total capacity 30 l
1 x Cleansers basket 4.1 l, 1 x Lid 18 l,
1 x utensil depot
- **Type of installation: inside available drawer,** side-wall-thickness 16 - 19 mm
- Nominal drawer-depth \geq 450 mm
- Sheet metal system Lid
- Colour: Metal parts silver-coloured
- Product dimensions: D x H, 433 x 330 mm
- Packing dimensions: W x D x H, 425 x 315 x 455 mm
- Weight incl. packing: 8,1 kg

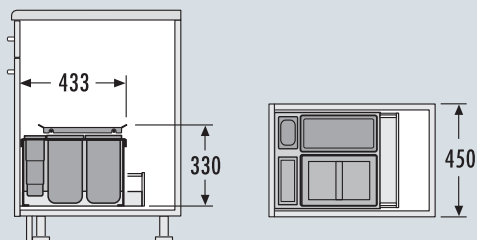

Inset



Einsatz für Schränke mit 450 mm Breite mit Frontauszug
For cabinets with pull-out shelf from 450 mm width

Separato K

Hailo AS Separato K 450 18/8/8/D

3620461



- Trennung: 3-fach
- Abfalleimer: 1 x 18 l, 2 x 8 l, Gesamtvolumen 34 l, 1 x Behälterdeckel 8 l
- **Montageart: Schubkastenmontage,** Seitenwandstärke 16 - 19 mm
- Schubkasten Nenntiefe ≥ 500 mm
- Kunststoff-Deckel herausziehbar, Seitenwandmontage
- Farbe: Kunststoffteile hellgrau
- Produkt-Maße: B x T x H, 407 x 491 x 340 mm
- Verpackungsmaße: B x T x H, 510 x 420 x 285 mm
- Gewicht mit Verpackung: 3,7 kg

- Separation: 3-fold
- Inner bins: 1 x 18 l, 2 x 8 l, Total capacity 34 l
1 x Lid 8 l
- **Type of installation: inside available drawer,**
side-wall-thickness 16 - 19 mm
- Nominal drawer-depth ≥ 500 mm
- Plastic-lid single extension, sidewall-mounted
- Colour: Plastic parts light-grey
- Product dimensions: W x D x H, 407 x 491 x 340 mm
- Packing dimensions: W x D x H, 510 x 420 x 285 mm
- Weight incl. packing: 3,7 kg

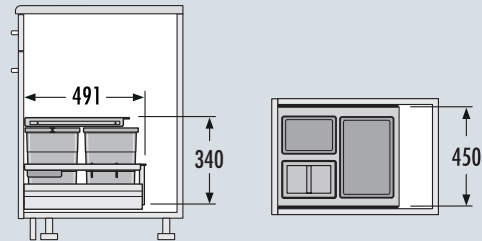

45 cm

Übrigens, wussten Sie, ...



dass Hailo Einbautechnik weltweit
in über 80 Länder exportiert?

By the way, did you know...

that Hailo Built-In Technology
exports to more than 80 countries
around the world?

Swing

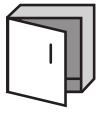

Für Schränke ab 500 mm Breite mit Drehtür
For hinged door cabinets from 500 mm width



50 cm

Swing



Für Schränke ab 500 mm Breite mit Drehtür
For hinged door cabinets from 500 mm width

Easy Cargo

Hailo AS Easy Cargo 30/19

3668501



- Trennung: 2-fach
- Abfalleimer: 1 x 30 l, 1 x 19 l, Gesamtvolumen 49 l
- **Montageart: Bodenmontage**
- Auszugsschienen: Vollauszug
- Praktische Ablagemulde im Deckel integriert
- Farbe: Metallteile silberfarben, Kunststoffteile hellgrau
- Produkt-Maße: B x T x H, 430 x 465 x 455 mm
- Verpackungsmaße: B x T x H, 455 x 510 x 470 mm
- Gewicht mit Verpackung: 8,1 kg



Raumspär Tandem S

Hailo AS Raumspär Tandem S 18/12

3644701



- Trennung: 2-fach
- Abfalleimer: 1 x 18 l, 1 x 12 l, Gesamtvolumen 30 l
- **Montageart: Bodenmontage**
- Auszugsschienen: Vollauszug
- Praktische Ablagemulde im Deckel integriert
- Farbe: Metallteile silberfarben, Kunststoffteile hellgrau
- Produkt-Maße: B x T x H, 434 x 330 x 347 mm
- Verpackungsmaße: B x T x H, 490 x 360 x 360 mm
- Gewicht mit Verpackung: 5 kg



Raumspär Tandem S

Hailo AS Raumspär Tandem S 12/8/8/D

3644731



- Trennung: 3-fach
- Abfalleimer: 1 x 12 l, 2 x 8,5 l, Gesamtvolumen 29 l, 1 x Behälterdeckel 8,5 l
- **Montageart: Bodenmontage**
- Auszugsschienen: Vollauszug
- Praktische Ablagemulde im Deckel integriert
- Farbe: Metallteile silberfarben, Kunststoffteile hellgrau
- Produkt-Maße: B x T x H, 434 x 330 x 347 mm
- Verpackungsmaße: B x T x H, 490 x 360 x 360 mm
- Gewicht mit Verpackung: 5 kg



Passend für Schränke 50 60 cm
Suitable for cabinets

- Separation: 2-fold
- Inner bins: 1 x 30 l, 1 x 19 l, Total capacity 49 l
- **Type of installation: bottom-mounted**
- Slides: full extension
- Practical storage area integrated in the lid
- Colour: Metal parts silver-coloured, Plastic parts light grey
- Product dimensions: W x D x H, 430 x 465 x 455 mm
- Packing dimensions: W x D x H, 455 x 510 x 470 mm
- Weight incl. packing: 8,1 kg

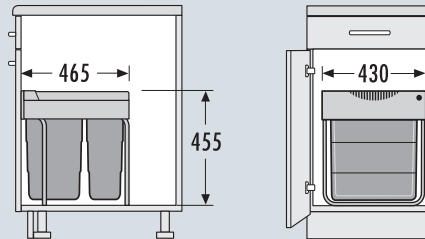

Passend für Schränke 50 60 cm
Suitable for cabinets

- Separation: 2-fold
- Inner bins: 1 x 18 l, 1 x 12 l, Total capacity 30 l
- **Type of installation: bottom-mounted**
- Slides: full extension
- Practical storage area integrated in the lid
- Colour: Metal parts silver-grey, Plastic parts light grey
- Product dimensions: W x D x H, 434 x 330 x 347 mm
- Packing dimensions: W x D x H, 490 x 360 x 360 mm
- Weight incl. packing: 5 kg

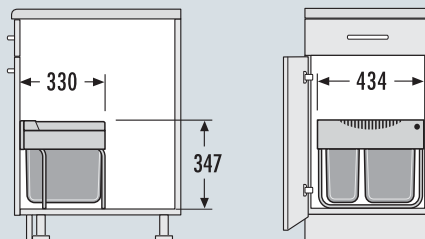

Passend für Schränke 50 60 cm
Suitable for cabinets

- Separation: 3-fold
- Inner bins: 1 x 12 l, 2 x 8.5 l, Total capacity 29 l
1 x Lid 8.5 l

- **Type of installation: bottom-mounted**
- Slides: full extension
- Practical storage area integrated in the lid
- Colour: Metal parts silver-coloured, Plastic parts light grey
- Product dimensions: W x D x H, 434 x 330 x 347 mm
- Packing dimensions: W x D x H, 490 x 360 x 360 mm
- Weight incl. packing: 5 kg

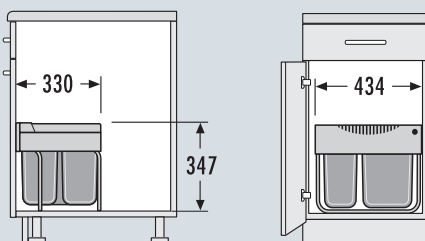



Übrigens, wussten Sie, ... dass Hailo Einbautechnik Produkte mit über 100.000 Auszugszyklen getestet werden, bevor sie auf den Markt kommen?

By the way, did you know... that Hailo Built-In Technology Products are tested on more than 100,000 pull-out cycles before they reach the market?

Slide



Für Schränke mit 500 mm Breite mit Frontauszug
For cabinets with front-mounted door of 500 mm width



50 cm



Slide



Für Schränke mit 500 mm Breite mit Frontauszug
For front-mount-door cabinets of 500 mm width

Cargo Synchro



Hailo AS Cargo Synchro 500 28/18

3608521



- Trennung: 2-fach
- Abfalleimer: 1 x 28 l, 1 x 18 l, Gesamtvolumen 46 l
- Montageart: Seitenwandmontage, selbstjustierend 16 - 19 mm
- **Auszugsschienen: abgedeckter, gedämpfter Selbststeinzug mit synchronisiertem Überauszug**
- Systemtiefe: 400 mm
- Herausfahrender Systemdeckel aus Metall/Kunststoff, vollflächig belegt mit rutschfester Gummimatte
- Farbe: Metall- und Kunststoffteile slate-grey
- Produkt-Maße: B x T x H, 462-468 x 400 x 424 mm
- Verpackungsmaße: B x T x H, 645 x 400 x 440 mm
- Gewicht mit Verpackung: 11,2 kg

Cargo Synchro



Hailo AS Cargo Synchro 500 18/13/13/D

3608531



- Trennung: 3-fach
- Abfalleimer: 1 x 18 l, 2 x 13 l, Gesamtvolumen 44 l, 1 x Behälterdeckel 13 l
- Montageart: Seitenwandmontage, selbstjustierend 16 - 19 mm
- **Auszugsschienen: abgedeckter, gedämpfter Selbststeinzug mit synchronisiertem Überauszug**
- Systemtiefe: 400 mm
- Herausfahrender Systemdeckel aus Metall/Kunststoff, vollflächig belegt mit rutschfester Gummimatte
- Farbe: Metall- und Kunststoffteile slate-grey
- Produkt-Maße: B x T x H, 462-468 x 400 x 424 mm
- Verpackungsmaße: B x T x H, 645 x 400 x 440 mm
- Gewicht mit Verpackung: 11,5 kg

Euro Cargo 50

Hailo AS Euro Cargo 500 38/38

3619501



- Trennung: 2-fach
- Abfalleimer: 2 x 38 l, Gesamtvolumen 76 l
- Montageart: Seitenwandmontage, selbstjustierend 16 - 19 mm, mit 4 x 25 mm Distanzstücken, auch für 50 cm Drehtür geeignet.
- **Auszugsschienen: abgedeckter Überauszug**
- Systemtiefe 528 mm
- Metallsystemdeckel
- Farbe: Metallteile Stahlblech silberfarben
- Produkt-Maße: B x T x H, 462-468 x 528 x 545 mm
- Verpackungsmaße: B x T x H, 490 x 320 x 620 mm
- Gewicht mit Verpackung: 12,7 kg

- Separation: 2-fold
- Inner bins: 1 x 28 l, 1 x 18 l, Total capacity 46 l
- Type of installation: side-wall-mounted, self-adjusting to 16 - 19 mm side walls
- **Slides: covered, dampened slides with self-closing device with fully synchronized over-travel**
- System-depth: 400 mm
- Pullout metal/plastic system lid, with anti-slip rubber mat
- Colour: Metal parts powder coated slate-grey, plastic parts slate-grey
- Product dimensions: W x D x H, 462-468 x 400 x 424 mm
- Packing dimensions: W x D x H, 645 x 400 x 440 mm
- Weight incl. packing: 11,2 kg

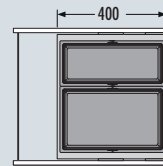
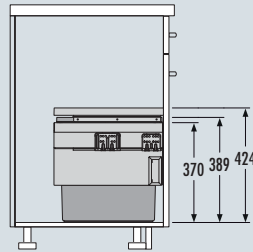

- Separation: 3-fold
- Inner bins: 1 x 18 l, 2 x 13 l, Total capacity 44 l, 1 x Lid 13 l
- Type of installation: side-wall-mounted, self-adjusting to 16 - 19 mm side walls
- **Slides: covered, dampened slides with self-closing device with fully synchronized over-travel**
- System-depth: 400 mm
- Pullout metal/ plastic system lid, with anti-slip rubber mat
- Colour: Metal parts powder coated slate-grey, plastic parts slate-grey
- Product dimensions: W x D x H, 462-468 x 400 x 424 mm
- Packing dimensions: W x D x H, 645 x 400 x 440 mm
- Weight incl. packing: 11,5 kg

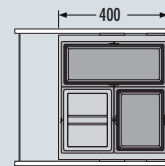
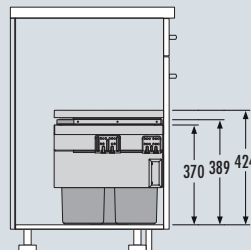

- Separation: 2-fold
- Inner bins: 2 x 38 l, Total capacity 76 l
- Type of installation: side-wall-mounted, self-adjusting to 16 - 19 mm side walls, with 4 x 25 mm spacer-blocks; also for 50 cm hinged door cabinet.
- **Slides: covered, non-dampened over travel slides**
- System-depth 528 mm
- Sheet metal system Lid
- Colour: Metal parts sheet steel silver-coloured
- Product dimensions: W x D x H, 462-468 x 528 x 545 mm
- Packing dimensions: W x D x H, 490 x 320 x 620 mm
- Weight incl. packing: 12,7 kg

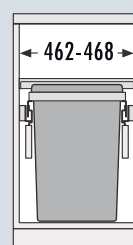
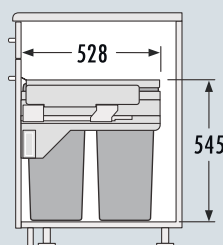

Slide



Für Schränke mit 500 mm Breite mit Frontauszug
For front-mount-door cabinets of 500 mm width

Euro Cargo 50 ST



Hailo AS Euro Cargo 500 ST 38/38



3619511

- Trennung: 2-fach
- Abfalleimer: 2 x 38 l, Gesamtvolumen 76 l
- Montageart: Seitenwandmontage, selbstjustierend 16 - 19 mm, mit 4 x 25 mm Distanzstücken, auch für 50 cm Drehtür geeignet.
- **Auszugsschienen: abgedeckter, gedämpfter Selbsteinzug mit Überauszug**
- Systemtiefe 528 mm
- Metallsystemdeckel
- Farbe: Metallteile Stahlblech silberfarben
- Produkt-Maße: B x T x H, 462-468 x 528 x 545 mm
- Verpackungsmaße: B x T x H, 490 x 320 x 620 mm
- Gewicht mit Verpackung: 12,7 kg



Euro Cargo S



Hailo AS Euro Cargo S 500 30/19



3610521

- Trennung: 2-fach
- Abfalleimer: 1 x 30 l, 1 x 19 l, Gesamtvolumen 49 l
- Montageart: Seitenwandmontage, selbstjustierend 16 - 19 mm
- **Auszugsschienen: abgedeckter, gedämpfter Selbsteinzug**
- Systemtiefe: 448 mm
- Metallsystemdeckel
- Farbe: Metallteile Stahlblech silberfarben
- Produkt-Maße: B x T x H, 462-468 x 403 x 439 mm
- Verpackungsmaße: B x T x H, 395 x 415 x 510 mm
- Gewicht mit Verpackung: 11,1 kg



Euro Cargo S



Hailo AS Euro Cargo S 500 19/13/13/D



3610531

- Trennung: 3-fach
- Abfalleimer: 1 x 19 l, 2 x 13 l, Gesamtvolumen 45 l, 1 x Behälterdeckel 13 l
- Montageart: Seitenwandmontage, selbstjustierend 16 - 19 mm
- **Auszugsschienen: abgedeckter, gedämpfter Selbsteinzug**
- Systemtiefe: 448 mm
- Metallsystemdeckel
- Farbe: Metallteile Stahlblech silberfarben
- Produkt-Maße: B x T x H, 462-468 x 403 x 439 mm
- Verpackungsmaße: B x T x H, 470 x 470 x 430 mm
- Gewicht mit Verpackung: 11,1 kg

- Separation: 2-fold
- Inner bins: 2 x 38 l, Total capacity 76 l
- Type of installation: side-wall-mounted, self-adjusting to 16 - 19 mm side walls, with 4 x 25 mm spacer-blocks; also for 50 cm hinged door cabinet.
- Slides: covered, dampened slides with self-closing device with over-travel
- System-depth 528 mm
- Sheet metal system Lid
- Metal parts sheet steel silver-coloured
- Product dimensions: W x D x H, 462-468 x 528 x 545 mm
- Packing dimensions: W x D x H, 490 x 320 x 620 mm
- Weight incl. packing 12,7 kg

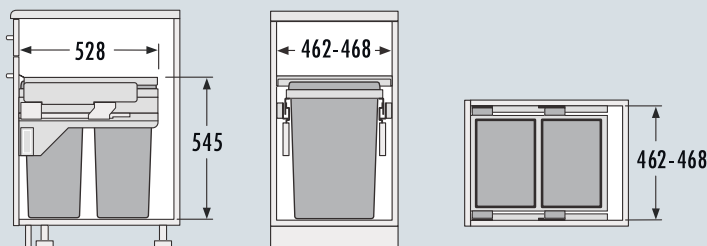

- Separation: 2-fold
- Inner bins: 1 x 30 l, 1 x 19 l, Total capacity 49 l
- Type of installation: side-wall-mounted, self-adjusting to 16 - 19 mm side walls
- Slides: covered, dampened slides with self-closing device
- System-depth: 448 mm
- Sheet metal system Lid
- Colour: Metal parts sheet steel silver-coloured
- Product dimensions: W x D x H, 462-468 x 403 x 439 mm
- Packing dimensions: W x D x H, 395 x 415 x 510 mm
- Weight incl. packing: 11,1 kg

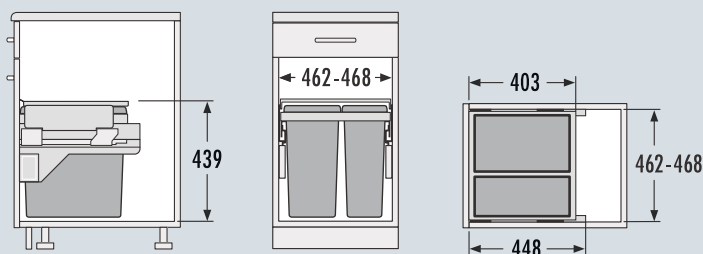

- Separation: 3-fold
- Inner bins: 1 x 19 l, 2 x 13 l, Total capacity 45 l, 1 x Lid 13 l
- Type of installation: side-wall-mounted, self-adjusting to 16 - 19 mm side walls
- Slides: covered, dampened slides with self-closing device
- System-depth: 448 mm
- Sheet metal system Lid
- Colour: Metal parts sheet steel silver-coloured
- Product dimensions: W x D x H, 462-468 x 403 x 439 mm
- Packing dimensions: W x D x H, 470 x 470 x 430 mm
- Weight incl. packing: 11,1 kg

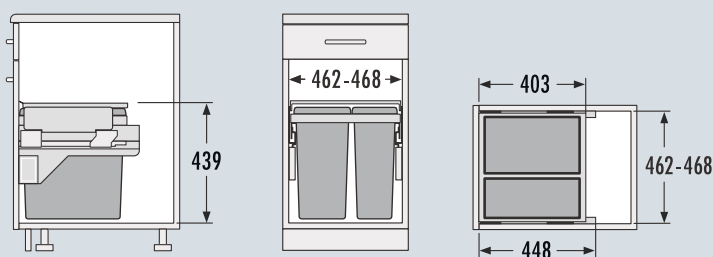

Slide



Für Schränke mit 500 mm Breite mit Frontauszug
For front-mount-door cabinets of 500 mm width

Cargo Soft



Hailo AS Cargo Soft 500 15/10/10/D/U

3610541



- Trennung: 3-fach
- Abfalleimer: 1 x 15 l, 2 x 10 l, Gesamtvolumen 35 l, 1 x Behälterdeckel 10 l, 1 x Utensiliendepot
- Montageart: Seitenwandmontage, selbstjustierend 16 - 19 mm
- **Auszugsschienen: abgedeckter, gedämpfter Selbsteinzug**
- Systemtiefe: 448 mm
- Metallsystemdeckel
- Farbe: Metallteile Stahlblech silberfarben
- Produkt-Maße: B x T x H, 462-468 x 403 x 388 mm
- Verpackungsmaße: B x T x H, 510 x 345 x 415 mm
- Gewicht mit Verpackung: 10,8 kg



Cargo Soft kurz short



Hailo AS Cargo Soft short 500 20/14

3610581



- Trennung: 2-fach
- Abfalleimer: 1 x 20 l, 1 x 14 l, Gesamtvolumen 34 l
- Montageart: Seitenwandmontage, selbstjustierend 16 - 19 mm
- **Auszugsschienen: abgedeckter, gedämpfter Selbsteinzug**
- Systemtiefe: 448 mm
- Metallsystemdeckel
- Farbe: Metallteile Stahlblech silberfarben
- Produkt-Maße: B x T x H, 462-468 x 332 x 370 mm
- Verpackungsmaße: B x T x H, 510 x 345 x 415 mm
- Gewicht mit Verpackung: 10,7 kg



Cargo Basic

Hailo AS Cargo Basic 500 15/10/10/D/U

3609501



- Trennung: 3-fach
- Abfalleimer: 1 x 15 l, 2 x 10 l, Gesamtvolumen 35 l, 1 x Behälterdeckel 10 l, 1 x Utensiliendepot
- Montageart: Seitenwandmontage,, selbstjustierend 16 - 19 mm
- **Auszugsschienen: Überauszug mit Selbsteinzug**
- Systemtiefe: 403 mm
- Metallsystemdeckel
- Farbe: Metallteile silberfarben
- Produkt-Maße: B x T x H, 462-468 x 403 x 387 mm
- Verpackungsmaße: B x T x H, 510 x 345 x 415 mm
- Gewicht mit Verpackung: 11,2 kg



- Separation: 3-fold
- Inner bins: 1 x 15 l, 2 x 10 l, Total capacity 35 l
1 x Lid 10 l, 1 x utensil depot
- Type of installation: side-wall-mounted, self-adjusting to 16 - 19 mm side walls
- Slides: covered, dampened slides with self-closing device
- System-depth: 448 mm
- Sheet metal system Lid
- Colour: Metal parts sheet steel silver-coloured
- Product dimensions: W x D x H, 462-468 x 403 x 388 mm
- Packing dimensions: W x D x H, 510 x 345 x 415 mm
- Weight incl. packing: 10,8 kg

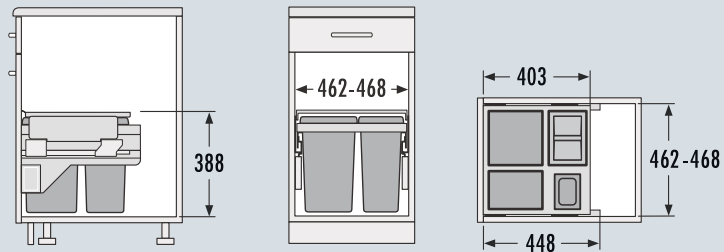

- Separation: 2-fold
- Inner bins: 1 x 20 l, 1 x 14 l, Total capacity 34 l
- Type of installation: side-wall-mounted, self-adjusting to 16 - 19 mm side walls
- Slides: covered, dampened slides with self-closing device
- System-depth: 448 mm
- Sheet metal system Lid
- Colour: Metal parts sheet steel silver-coloured
- Product dimensions: W x D x H, 462-468 x 332 x 370 mm
- Packing dimensions: W x D x H, 510 x 345 x 415 mm
- Weight incl. packing: 10,7 kg

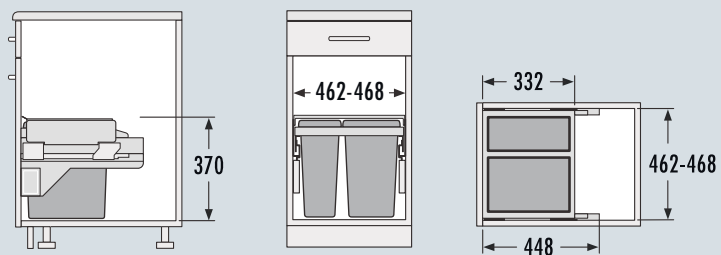

- Separation: 3-fold
- Inner bins: 1 x 15 l, 2 x 10 l, Total capacity 35 l,
1 x Lid 10 l, 1 x utensil depot
- Type of installation: side-wall-mounted, self-adjusting to 16 - 19 mm side walls
- Slides: non-dampened over travel slides
- System-depth: 403 mm
- Sheet metal system Lid
- Colour: Metal parts silver-coloured
- Product dimensions: W x D x H, 462-468 x 403 x 387 mm
- Packing dimensions: W x D x H, 510 x 345 x 415 mm
- Weight incl. packing: 11,2 kg

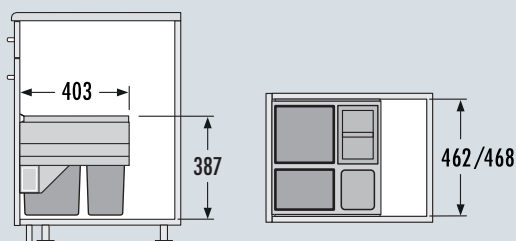

Slide



Für Schränke mit 500 mm Breite mit Frontauszug
For front-mount-door cabinets of 500 mm width

Hailo Kick and Go

Fußhebel

3691301

3691401

3691501



3691301 Fußhebel "Kick and go" für unteren Schubkasten
3691401 Fußhebel "Kick and go" für Cargo Basic, 3609
3691501 Fußhebel "Kick and go"
für Euro Cargo 3614 und 3619- 451+601

Die Cargos fahren per Fußdruck heraus

Mehr Infos auf Seite 202

Hailo Libero

Türöffner

3697101



Hailo Libero – Hands Free Opener

Die Öffnungsunterstützung von Hailo für ein automatisches, komfortables Öffnen aller Abfalltrennsysteme mit Frontanbindung und aller Auszugssysteme.

Ausführliche Beschreibung Seite 198

Hailo Libero 2.0

Türöffner

3697201



Hailo Libero – Hands Free Opener

Die Öffnungsunterstützung von Hailo für ein automatisches, komfortables Öffnen aller Abfalltrennsysteme mit Frontanbindung und aller Auszugssysteme.

Ausführliche Beschreibung Seite 200

Foot Pedal

3691301 Foot Pedal "Kick and go" for lower drawer
 3691401 Foot Pedal "Kick and go" for Cargo Basic
 3691501 Foot Pedal "Kick and go" for Euro Cargo 45
 & Euro Cargo 60

The Cargo leaves the cabinet by
 a light toe-kick – hands- free

More information page 202

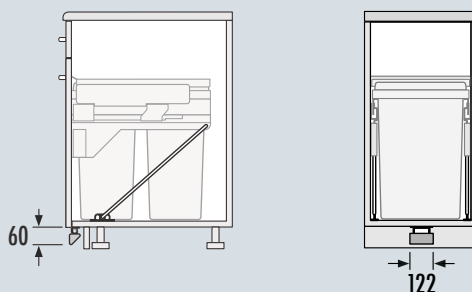

Door Opener

Hailo „Libero“ – Hands Free Opener

Hailo's electronic front-mount-door and drawer–
 opener „Libero“ offers an automatic, comfortable hands-free
 opening of all waste-recycling-systems with attached
 door-panel and of any common, also damped,
 drawer-mounted systems.

With 2-pin Euro-Plug, 230 V, IP 4.1 certified

More information page 198

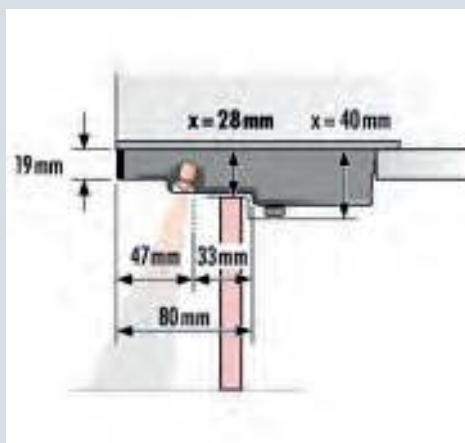

Door Opener

Hailo „Libero“ – Hands Free Opener

Hailo's electronic front-mount-door and drawer–
 opener „Libero“ offers an automatic, comfortable hands-free
 opening of all waste-recycling-systems with attached door-panel
 and of any common, also damped, drawer-mounted systems.
 With 2-pin Euro-Plug, 230 V, IP 4.1 certified

More information: page 200





Übrigens, wussten Sie, ...

dass Hailo die größte Eimervielfalt für jeden Bedarf vorhält?

By the way, did you know...

that Hailo provides the widest range of bins for all requirements?

Inset



Einsatz für Schränke ab 500 mm Breite mit Frontauszug
For cabinets with pull-out shelf from 500 mm width



50 cm

Inset



Einsatz für Schränke ab 500 mm Breite mit Frontauszug
For cabinets with pull-out drawer, from 500 mm width

XXL 50

Hailo AS XXL 500 12/8,5/8,5/D/P/P



3630501

- Trennung: 3-fach
- Abfalleimer: 1 x 12 l, 2 x 8,5 l, Gesamtvolumen 29 l, 2 x Putzmittelkorb 4,1 l, 1 x Behälterdeckel 12 l
- **Montageart: Schubkastenmontage,** Seitenwandstärke 16 bis 19 mm
- Schubkasten Nenntiefe \geq 450 mm
- Metallsystemdeckel
- Farbe: Metallteile silberfarben
- Produkt-Maße: T x H, 433 x 330 mm
- Verpackungsmaße: B x T x H, 455 x 315 x 475 mm
- Gewicht mit Verpackung: 8,5 kg



Triple XL 50

Hailo AS Triple XL 500 30/D/19



3631501

- Trennung: 2-fach
- Abfalleimer: 1 x 30 l, 1 x 19 l, Gesamtvolumen 49 l, 1 x Behälterdeckel 30 l
- **Montageart: Schubkastenmontage,** Seitenwandstärke 16 bis 19 mm
- Schubkasten Nenntiefe \geq 420 mm
- Metallsystemdeckel
- Farbe: Metallteile silberfarben
- Produkt-Maße: T x H, 400 x 430 mm
- Verpackungsmaße: B x T x H, 435 x 315 x 510 mm
- Gewicht mit Verpackung: 10 kg



Triple XL 50

Hailo AS Triple XL 500 19/13/13/D



3631531

- Trennung: 3-fach
- Abfalleimer: 1 x 19 l, 2 x 13 l, Gesamtvolumen 45 l, 1 x Behälterdeckel 13 l
- **Montageart: Schubkastenmontage** Seitenwandstärke 16 bis 19 mm
- Schubkasten Nenntiefe \geq 420 mm
- Metallsystemdeckel
- Farbe: Metallteile silberfarben
- Produkt-Maße: T x H, 400 x 430 mm
- Verpackungsmaße: B x T x H, 470 x 470 x 430 mm
- Gewicht mit Verpackung: 10 kg



Niedrige Variante
Low Type

- Separation: 3-fold
- Inner bins: 1 x 12 l, 2 x 8.5 l, Total capacity 29 l
2 x Cleaners basket 4.1 l, 1 x Lid 12 l
- **Type of installation: inside available drawer,**
side-wall-thickness 16 - 19 mm
- Nominal drawer-depth \geq 450 mm
- Sheet metal system Lid
- Colour: Metal parts silver-coloured
- Product dimensions: D x H, 433 x 330 mm
- Packing dimensions: W x D x H, 455 x 315 x 475 mm
- Weight incl. packing: 8,5 kg

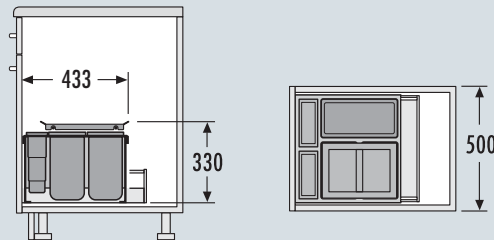

Hohe Variante
Tall Type

- Separation: 2-fold
- Inner bins: 1 x 30 l, 1 x 19 l, Total capacity 49 l
1 x Lid 30 l
- **Type of installation: inside available drawer,**
side-wall-thickness 16 - 19 mm
- Nominal drawer-depth \geq 420 mm
- Sheet metal system Lid
- Colour: Metal parts silver-coloured
- Product dimensions: D x H, 400 x 430 mm
- Packing dimensions: W x D x H, 435 x 315 x 510 mm
- Weight incl. packing: 10 kg

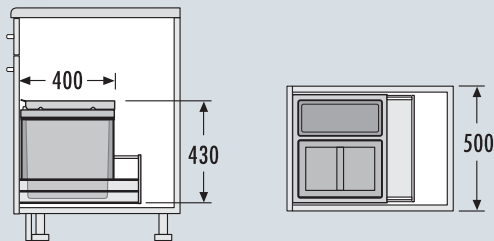

Hohe Variante
Tall Type

- Separation: 3-fold
- Inner bins: 19 l, 2 x 13 l, Total capacity 45 l
1 x Lid 13 l
- **Type of installation: inside available drawer,**
side-wall-thickness 16 - 19 mm
- Nominal drawer-depth \geq 420 mm
- Sheet metal system Lid
- Colour: Metal parts silver-coloured
- Product dimensions: D x H, 400 x 430 mm
- Packing dimensions: W x D x H, 470 x 470 x 430 mm
- Weight incl. packing: 10 kg

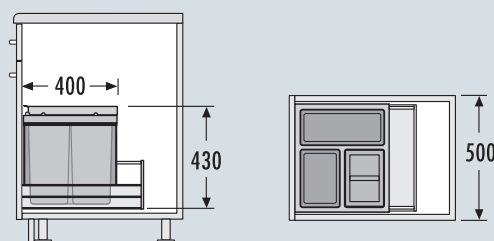

Inset



Einsatz für Schränke ab 500 mm Breite mit Frontauszug
For cabinets with pull-out drawer, from 500 mm width

Triple XL 50

Hailo AS Triple XL 500 15/10/10/D/U



3631511

- Trennung: 3-fach
- Abfalleimer: 1 x 15 l, 2 x 10 l, Gesamtvolumen 35 l, 1 x Behälterdeckel 10 l, 1 x Utensiliendepot
- **Montageart: Schubkastenmontage,** Seitenwandstärke 16 bis 19 mm
- Schubkasten Nenntiefe ≥ 420 mm
- Metallsystemdeckel
- Farbe: Metallteile silberfarben
- Produkt-Maße: T x H, 400 x 378 mm
- Verpackungsmaße: B x T x H, 435 x 315 x 510 mm
- Gewicht mit Verpackung: 10 kg



Separato K

Hailo AS Separato K 500 18/8/8/D



3620511

- Trennung: 3-fach
- Abfalleimer: 1 x 18 l, 2 x 8 l, Gesamtvolumen 34 l, 1 x Behälterdeckel 8 l
- **Montageart: Schubkastenmontage,** Seitenwandstärke 16 bis 19 mm
- Schubkasten Nenntiefe ≥ 500 mm
- Kunststoff-Deckel herausziehbar, Seitenwandmontage
- Farbe: Kunststoffteile hellgrau
- Produkt-Maße: B x T x H, 457 x 491 x 340 mm
- Verpackungsmaße: B x T x H, 510 x 470 x 285 mm
- Gewicht mit Verpackung: 4,1 kg





Mittlere Variante
Medium Type

- Separation: 3-fold
- Inner bins: 1 x 15 l, 2 x 10 l, Total capacity 35 l
1 x Lid 10 l, 1 x utensil depot
- **Type of installation: inside available drawer,**
side-wall-thickness 16 - 19 mm
- Nominal drawer-depth ≥ 420 mm
- Sheet metal system Lid
- Colour: metal parts silver-coloured
- Product dimensions: D x H, 400 x 378 mm
- Packing dimensions: W x D x H, 435 x 315 x 510 mm
- Weight incl. packing: 10 kg

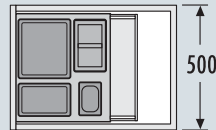
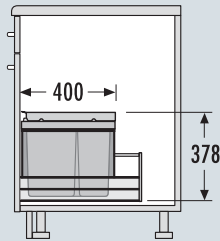

Mittlere Variante
Medium Type

- Separation: 3-fold
- Inner bins: 1 x 18 l, 2 x 8 l Total capacity 34 l
1 x Lid 8 l
- **Type of installation: inside available drawer,**
side-wall-thickness 16 - 19 mm
- Nominal drawer-depth ≥ 500 mm
- Plastic-lid single extension, sidewall-mounted
- Colour: Plastic parts light-grey
- Product dimensions: W x D x H, 457 x 491 x 340 mm
- Packing dimensions: W x D x H, 510 x 470 x 285 mm
- Weight incl. packing: 4,1kg

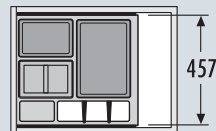
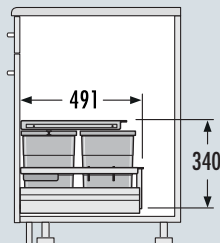

50 cm



Übrigens, wussten Sie, ...

dass Hailo bereits in der Gründungszeit 1947 Abfallsammler produzierte?

By the way, did you know...

that Hailo has been producing waste bins right from the outset, early 1947?

Swing



Für Schränke ab 600 mm Breite mit Drehtür
For hinged door cabinets from 600 mm width



60 cm

Swing



Für Schränke ab 600 mm Breite mit Drehtür
For hinged door cabinets from 600 mm width

Raumspartandem S plus

Hailo AS Raumspartandem S plus 18/12

3644801



- Trennung: 2-fach
- Abfalleimer: 1 x 18 l, 1 x 12 l, Gesamtvolumen 30 l
- **Montageart: Bodenmontage**
- Auszugsschienen: Vollauszug mit Ausfahrautomatik
- Metallsystemdeckel, Seitenwandmontage
- Farbe: Metallteile silberfarben, Kunststoffteile hellgrau
- Produkt-Maße: B x T x H, 556 x 367 x 376 mm
- Verpackungsmaße: B x T x H, 580 x 400 x 360 mm
- Gewicht mit Verpackung: 8,5 kg

Raumspartandem S plus

Hailo AS Raumspartandem S plus 12/8/8/D

3644831



- Trennung: 3-fach
- Abfalleimer: 1 x 12 l, 2 x 8,5 l, Gesamtvolumen 29 l, 1 x Behälterdeckel 8,5 l
- **Montageart: Bodenmontage**
- Auszugsschienen: Vollauszug mit Ausfahrautomatik
- Metallsystemdeckel, Seitenwandmontage
- Farbe: Metallteile silberfarben, Kunststoffteile hellgrau
- Produkt-Maße: B x T x H, 556 x 367 x 376 mm
- Verpackungsmaße: B x T x H, 580 x 400 x 360 mm
- Gewicht mit Verpackung: 8,1 kg

Raumspartandem S plus

Hailo AS Raumspartandem S plus 18/12

3644821



- Trennung: 2-fach
- Abfalleimer: 1 x 18 l, 1 x 12 l, Gesamtvolumen 30 l
- **Montageart: Bodenmontage**
- Auszugsschienen: Vollauszug mit Ausfahrautomatik
- Praktische Ablagemulde im Kunststoff-Deckel integriert (Seitenwandunabhängig)
- Farbe: Metallteile silberfarben, Kunststoffteile hellgrau
- Produkt-Maße: B x T x H, 432 x 338 x 360 mm
- Verpackungsmaße: B x T x H, 490 x 360 x 360 mm
- Gewicht mit Verpackung: 8,5 kg

- Separation: 2-fold
- Inner bins: 1 x 18 l, 1 x 12 l, Total capacity 30 l
- **Type of installation: bottom-mounted**
- Slides: full extension with automatic door-follower
- Sheet metal system Lid, sidewall-mounted
- Colour: Metal parts silver-coloured, Plastic parts light grey
- Product dimensions: W x D x H, 556 x 367 x 376 mm
- Packing dimensions: W x D x H, 580 x 400 x 360 mm
- Weight incl. packing: 8,5 kg

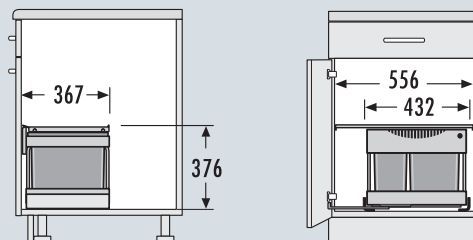

- Separation: 3-fold
- Inner bins: 1 x 12 l, 2 x 8.5 l, Total capacity 29 l, 1x Lid 8.5 l
- **Type of installation: bottom-mounted, in single-door-cabinet**
- Slides: full extension with automatic door-follower
- Sheet metal system Lid, sidewall-mounted
- Colour: Metal parts silver-coloured, Plastic parts light grey
- Product dimensions: W x D x H, 556 x 367 x 376 mm
- Packing dimensions: W x D x H, 580 x 400 x 360 mm
- Weight incl. packing: 8,1 kg

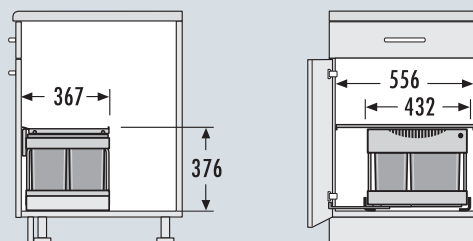

- Separation: 2-fold
- Inner bins: 1 x 18 l, 1 x 12 l, Total capacity 30 l
- **Type of installation: bottom-mounted**
- Slides: full extension with automatic door-follower
- Practical storage area integrated in the plastic-lid (fixed on frame, independent of sidewall)
- Colour: Metal parts silver-coloured, Plastic parts light-grey
- Product dimensions: W x D x H, 432 x 338 x 360 mm
- Packing dimensions: W x D x H, 490 x 360 x 360 mm
- Weight incl. packing: 8,5 kg

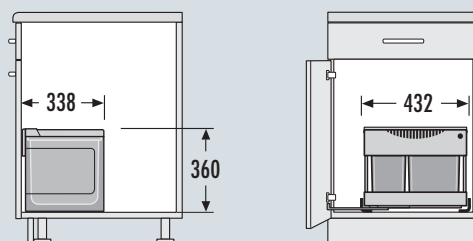

Übrigens, wussten Sie, ...

dass Hailo für die meisten Produkte eine Montageanleitung auf der Website zur Verfügung stellt?

By the way, did you know...

that Hailo installation instructions for most products are available on the website ?



Slide



Für Schränke mit 600 mm Breite mit Frontauszug
For cabinets with front-mount-door of 600 mm width



60 cm

Slide



Für Schränke mit 600 mm Breite mit Frontauszug
For cabinets with front-mount-door of 600 mm width

Cargo Synchro



Hailo AS Cargo Synchro 600 28/28



3608621

- Trennung: 2-fach
- Abfalleimer: 2 x 28 l, Gesamtvolumen 56 l
- Montageart: Seitenwandmontage, selbstjustierend 16 - 19 mm
- **Auszugsschienen: abgedeckter, gedämpfter Selbsteinzug mit synchronisiertem Überauszug**
- Systemtiefe: 400 mm
- Herausfahrbare Metallsystemdeckel/Kunststoff, vollflächig belegt mit rutschfester Gummimatte
- Farbe: Metall- und Kunststoffteile slate-grey
- Produkt-Maße: B x T x H, 562-568 x 400 x 424 mm
- Verpackungsmaße: B x T x H, 575 x 340 x 480 mm
- Gewicht mit Verpackung: 11,8 kg



Cargo Synchro



Hailo AS Cargo Synchro 600 28/13/13/D



3608631

- Trennung: 3-fach
- Abfalleimer: 1 x 28 l, 2 x 13 l, Gesamtvolumen 54 l, 1 x Behälterdeckel 13 l
- Montageart: Seitenwandmontage, selbstjustierend 16 - 19 mm
- **Auszugsschienen: abgedeckter, gedämpfter Selbsteinzug mit synchronisiertem Überauszug**
- Systemtiefe: 400 mm
- Herausfahrbare Metallsystemdeckel/Kunststoff, vollflächig belegt mit rutschfester Gummimatte
- Farbe: Metall- und Kunststoffteile slate-grey
- Produkt-Maße: B x T x H, 562-568 x 400 x 424 mm
- Verpackungsmaße: B x T x H, 575 x 340 x 480 mm
- Gewicht mit Verpackung: 12,1 kg



Euro Cargo 60

Hailo AS Euro Cargo 600 38/38/12/D/2,5



3619601

- Trennung: 4-fach
- Abfalleimer: 2 x 38 l, 1 x 12 l, 1 x 2,5 l, Gesamtvolumen 91 l, 1 x Behälterdeckel 12 l
- Montageart: Seitenwandmontage, selbstjustierend 16 - 19 mm
- **Auszugsschienen: abgedeckter Überauszug**
- Systemtiefe 528 mm
- Metallsystemdeckel
- Farbe: Metallteile Stahlblech silberfarben
- Produkt-Maße: B x T x H, 562-568 x 528 x 545 mm
- Verpackungsmaße: B x T x H, 590 x 325 x 620 mm
- Gewicht mit Verpackung: 14,9 kg



- Separation: 2-fold
- Inner bins: 2 x 28 l, Total capacity 56 l
- Type of installation: side-wall-mounted, self-adjusting to 16 - 19 mm side walls
- **Slides: covered, dampened slides with self-closing device with fully synchronized over-travel**
- System-depth: 400 mm
- Pullout metal/plastic system lid, with anti-slip rubber mat
- Colour: Metal parts powder coated slate-grey, plastic parts slate-grey
- Product dimensions: W x D x H, 562-568 x 400 x 424 mm
- Packing dimensions: W x D x H, 575 x 340 x 480 mm
- Weight incl. packing: 11,8 kg

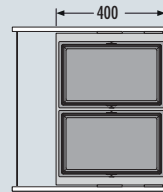
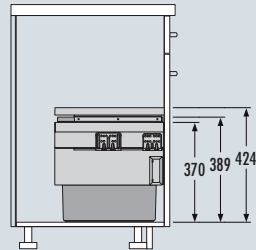

- Separation: 3-fold
- Inner bins: 1 x 28 l, 2 x 13 l, Total capacity 54 l
1 x Lid 13 l
- Type of installation: side-wall-mounted, self-adjusting to 16 - 19 mm side walls
- **Slides: covered, dampened slides with self-closing device with fully synchronized over-travel**
- System-depth: 400 mm
- Pullout metal/ plastic system lid, with anti-slip rubber mat
- Colour: Metal parts powder coated slate-grey, plastic parts slate-grey
- Product dimensions: W x D x H, 562-568 x 400 x 424 mm
- Packing dimensions: W x D x H, 575 x 340 x 480 mm
- Weight incl. packing: 12,1 kg

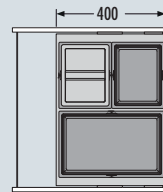
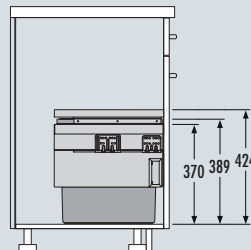

- Separation: 4-fold
- Inner bins: 2 x 38 l, 1 x 12 l, 1 x 2.5 l, Total capacity 91 l
1 x Lid 12 l
- Type of installation: side-wall-mounted, self-adjusting to 16 - 19 mm side walls
- **Slides: covered, non-dampened over travel slides**
- System-depth 528 mm
- Sheet metal system Lid
- Colour: Metal parts sheet steel silver-coloured
- Product dimensions: W x D x H, 562-568 x 528 x 545 mm
- Packing dimensions: W x D x H, 590 x 325 x 620 mm
- Weight incl. packing: 14,9 kg

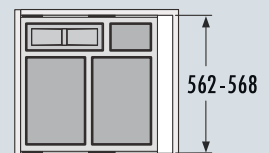
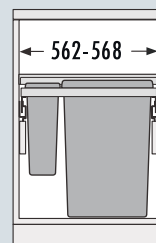
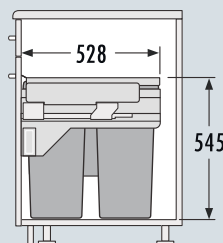

Slide



Für Schränke mit 600 mm Breite mit Frontauszug
For cabinets with front-mount-door of 600 mm width

Euro Cargo 60 ST



Hailo AS Euro Cargo 600 ST 38/38/12/D/2,5

3619611



- Trennung: 4-fach
- Abfalleimer: 2 x 38 l, 1 x 12 l, 1 x 2,5 l, Gesamtvolumen 91 l, 1 x Behälterdeckel 12 l
- Montageart: Seitenwandmontage, selbstjustierend 16 - 19 mm
- **Auszugsschienen: abgedeckter, gedämpfter Selbsteinzug mit Überauszug**
- Systemtiefe 528 mm
- Metallsystemdeckel
- Farbe: Metallteile Stahlblech silberfarben
- Produkt-Maße: B x T x H, 562-568 x 528 x 545 mm
- Verpackungsmaße: B x T x H, 590 x 325 x 620 mm
- Gewicht mit Verpackung: 14,9 kg



Euro Cargo S



Hailo AS Euro Cargo S 600 30/30

3610621



- Trennung: 2-fach
- Abfalleimer: 2 x 30 l, Gesamtvolumen 60 l
- Montageart: Seitenwandmontage, selbstjustierend 16 - 19 mm
- **Auszugsschienen: abgedeckter, gedämpfter Selbsteinzug**
- Systemtiefe: 448 mm
- Metallsystemdeckel
- Farbe: Metallteile Stahlblech silberfarben
- Produkt-Maße: B x T x H, 562-568 x 403 x 439 mm
- Verpackungsmaße: B x T x H, 490 x 320 x 620 mm
- Gewicht mit Verpackung: 11,45 kg



Euro Cargo S



Hailo AS Euro Cargo S 600 30/13/13/D

3610631



- Trennung: 3-fach
- Abfalleimer: 1 x 30 l, 2 x 13 l, Gesamtvolumen 56 l, 1 x Behälterdeckel 13 l
- Montageart: Seitenwandmontage, selbstjustierend 16 - 19 mm
- **Auszugsschienen: abgedeckter, gedämpfter Selbsteinzug**
- Systemtiefe: 448 mm
- Metallsystemdeckel
- Farbe: Metallteile Stahlblech silberfarben
- Produkt-Maße: B x T x H, 562-568 x 403 x 439 mm
- Verpackungsmaße: B x T x H, 490 x 320 x 620 mm
- Gewicht mit Verpackung: 11,45 kg



- Separation: 4-fold
- Inner bins: 2 x 38 l, 1 x 12 l, 1 x 2.5 l, Total capacity 91 l, 1 x Lid 12 l
- Type of installation: side-wall-mounted, self-adjusting to 16 - 19 mm side walls
- Slides: covered, dampened slides with self-closing device with over-travel
- System-depth 528 mm
- Sheet metal system Lid
- Colour: Metal parts sheet steel silver-coloured
- Product dimensions: W x D x H, 562-568 x 528 x 545 mm
- Packing dimensions: W x D x H, 590 x 325 x 620 mm
- Weight incl. packing 14,9 kg

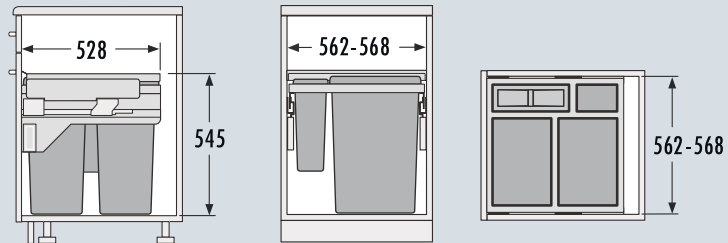

- Separation: 2-fold
- Inner bins: 2 x 30 l, Total capacity 60 l
- Type of installation: side-wall-mounted, self-adjusting to 16 - 19 mm side walls
- Slides: covered, dampened slides with self-closing device
- System-depth: 448 mm
- Sheet metal system Lid
- Colour: Metal parts sheet steel platinum-silver
- Product dimensions: W x D x H, 562-568 x 403 x 439 mm
- Packing dimensions: W x D x H, 490 x 320 x 620 mm
- Weight incl. packing: 11,45 kg

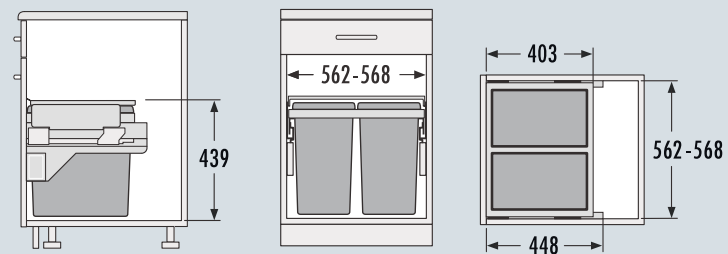

- Separation: 3-fold
- Inner bins: 1 x 30 l, 2 x 13 l, Total capacity 56 l, 1 x Lid 13 l
- Type of installation: side-wall-mounted, self-adjusting to 16 - 19 mm side walls
- Slides: covered, dampened slides with self-closing device
- System-depth: 448 mm
- Sheet metal system Lid
- Colour: Metal parts sheet steel silver-coloured
- Product dimensions: W x D x H, 562-568 x 403 x 439 mm
- Packing dimensions: W x D x H, 490 x 320 x 620 mm
- Weight incl. packing: 11,45 kg

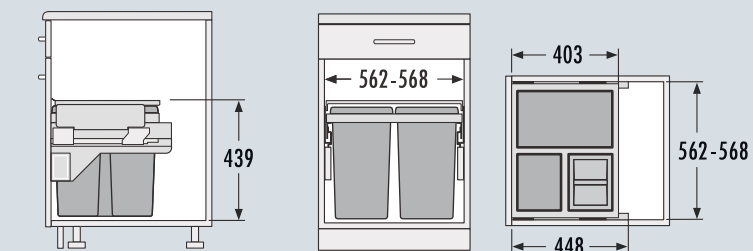

Slide



Für Schränke mit 600 mm Breite mit Frontauszug
For cabinets with front-mount-door of 600 mm width

Cargo Soft BIG



Hailo AS Cargo Soft Big 600 28/28

3610661



- Trennung: 2-fach
- Abfalleimer: 2 x 28 l, Gesamtvolumen 56 l
- Montageart: Seitenwandmontage, selbstjustierend 16 - 19 mm
- **Auszugsschienen: abgedeckter, gedämpfter Selbsteinzug mit Überauszug**
- Systemtiefe: 448 mm
- Metallsystemdeckel ausziehbar, Teilauszug
- Farbe: Rahmengestell Metallteile silberfarben
- Produkt-Maße: B x T x H, 562-568 x 434 x 375 mm
- Verpackungsmaße: B x T x H, 490 x 320 x 620 mm
- Gewicht mit Verpackung: 12,2 kg



Cargo Soft BIG Combi



Hailo AS Cargo Soft Big Combi 600 28/28

3205621



Cargo Soft BIG inkl. On Top

- Trennung: 2-fach
- Abfalleimer: 2 x 28 l, Gesamtvolumen 56 l
- 2 x Behälter 4 l, (hellgrün/weiß), 2 x Behälterdeckel 4 l
- Montageart: Seitenwandmontage, selbstjustierend 16 - 19 mm
- **Auszugsschienen: abgedeckter, gedämpfter Selbsteinzug mit Überauszug**
- Systemtiefe: 448 mm
- Tablarauszug aus Kunststoff, ausziehbar, Teilauszug
- Farbe: Metallteile silberfarben
- Produkt-Maße: B x T x H, 562-568 x 434 x 480 mm
- Verpackungsmaße: B x T x H, 455 x 455 x 590 mm
- Gewicht mit Verpackung: 13 kg



Cargo Soft BIG



Hailo AS Cargo Soft Big 600 28/15/10/D

3610671



- Trennung: 3-fach
- Abfalleimer: 1 x 28 l, 1 x 15 l, 1 x 10 l, Gesamtvolumen 53 l, 1 x Behälterdeckel 10 l
- Montageart: Seitenwandmontage, selbstjustierend 16 - 19 mm
- **Auszugsschienen: abgedeckter, gedämpfter Selbsteinzug mit Überauszug**
- Systemtiefe: 448 mm
- Metallsystemdeckel ausziehbar, Teilauszug
- Farbe: Metallteile silberfarben
- Produkt-Maße: B x T x H, 562-568 x 434 x 375 mm
- Verpackungsmaße: B x T x H, 490 x 320 x 620 mm
- Gewicht mit Verpackung: 12,2 kg



- Separation: 2-fold
- Inner bins: 2 x 28 l, Total capacity 56 l
- Type of installation: side-wall-mounted, self-adjusting to 16 - 19 mm side walls
- Slides: covered, dampened slides with self-closing device with over-travel
- System-depth: 448 mm
- Sheet metal system Lid single-extension
- Colour: Metall Parts silver coloured,
- Product Dimensions: B x T x H, 562-568 x 434 x 375 mm
- Packing dimensions: W x D x H, 490 x 320 x 620 mm
- Weight incl. packing: 12,2 kg

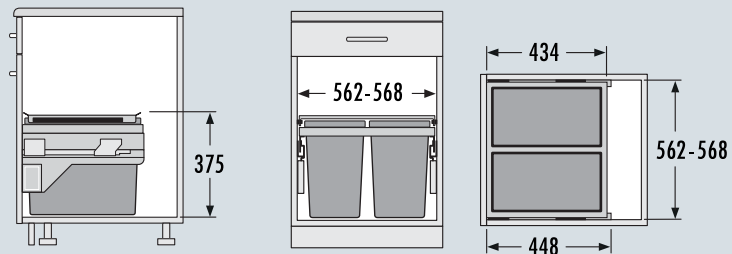

- Separation: 2-fold
- Inner bins: 2 x 28 l, Total capacity 56 l
- 2 x Container 4 l, (green/white), 2 x Lid 4 l
- Type of installation: side-wall-mounted, self-adjusting to 16 - 19 mm side walls
- Slides: covered, dampened slides with self-closing device with over-travel
- System-depth: 448 mm
- Plastic-Pullout single extension Lid
- Colour: Metall Parts silver coloured,
- Product Dimensions: B x T x H, 562-568 x 434 x 480 mm
- Packing dimensions: W x D x H, 455 x 455 x 590 mm
- Weight incl. packing: 13 kg

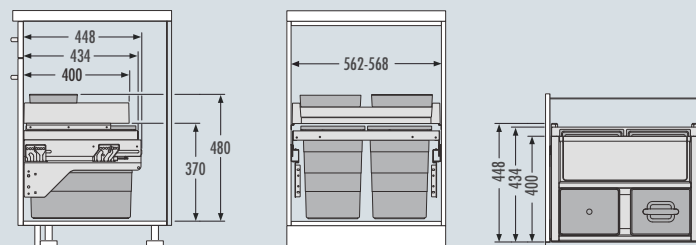

- Separation: 3-fold
- Inner bins: 1 x 28 L, 1 x 15 L, 1 x 10L, Total capacity 53 L
1 x Lid 10 l
- Type of installation: side-wall-mounted, self-adjusting to 16 - 19 mm side walls
- Slides: covered, dampened slides with self-closing device with over-travel
- System-depth: 448 mm
- Sheet metal system Lid single-extension
- Colour: Metall Parts silver coloured
- Product Dimensions: B x T x H, 562-568 x 434 x 375 mm
- Packing dimensions: W x D x H, 490 x 320 x 620 mm
- Weight incl. packing: 12,2 kg

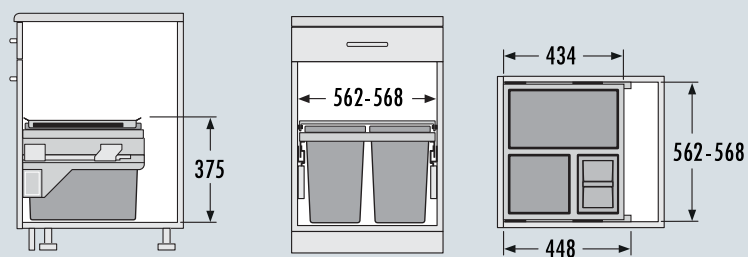

Slide



Für Schränke mit 600 mm Breite mit Frontauszug For front-mount-door cabinets of 600 mm width

Cargo Soft



Hailo AS Cargo Soft 600 24/10/10/10/D

3610641



- Trennung: 4-fach
- Abfalleimer: 1 x 24 l, 3 x 10 l, Gesamtvolumen 54 l, 1 x Behälterdeckel 10 l
- Montageart: Seitenwandmontage, selbstjustierend 16 - 19 mm
- **Auszugsschienen: abgedeckter, gedämpfter Selbsteinzug**
- Systemtiefe: 448 mm
- Metallsystemdeckel
- Farbe: Metallteile Stahlblech silberfarben
- Produkt-Maße: B x T x H, 562-568 x 403 x 388 mm
- Verpackungsmaße: B x T x H, 490 x 320 x 620 mm
- Gewicht mit Verpackung: 12,25 kg

Cargo Soft kurz short



Hailo AS Cargo Soft short 600 20/10/10/10/D

3610681



- Trennung: 3-fach
- Abfalleimer: 1 x 20 l, 2 x 10 l, Gesamtvolumen 40 l, 1 x Behälterdeckel 10 l
- Montageart: Seitenwandmontage, selbstjustierend 16 - 19 mm
- **Auszugsschienen: abgedeckter, gedämpfter Selbsteinzug**
- Systemtiefe: 448 mm
- Metallsystemdeckel
- Farbe: Metallteile Stahlblech silberfarben
- Produkt-Maße: B x T x H, 562-568 x 332 x 370 mm
- Verpackungsmaße: B x T x H, 490 x 320 x 620 mm
- Gewicht mit Verpackung: 12,2 kg

Cargo Soft low



Hailo AS Cargo Soft low 600 15/7/7/7/D

3610691



Extra-niedrig



- Trennung: 4-fach
- Abfalleimer: 1 x 15 l, 3 x 7 l, Gesamtvolumen 36 l, 1 x Behälterdeckel 7 l
- Montageart: Seitenwandmontage, selbstjustierend 16 - 19 mm
- **Auszugsschienen: abgedeckter, gedämpfter Selbsteinzug**
- Systemtiefe: 448 mm
- Metallsystemdeckel
- Farbe: Rahmengestell Metallteile silberfarben
- Produkt-Maße: B x T x H, 562-568 x 403 x 306 mm
- Verpackungsmaße: B x T x H, 490 x 320 x 620 mm
- Gewicht mit Verpackung: 12,2 kg

- Separation: 4-fold
- Inner bins: 1 x 24 l, 3 x 10 l, Total capacity 54 l
1 x Lid 10 l
- Type of installation: side-wall-mounted, self-adjusting to 16 - 19 mm side walls
- Slides: covered, dampened slides with self-closing device
- System-depth: 448 mm
- Sheet metal system Lid
- Colour: Metal parts sheet steel silver-coloured
- Product dimensions: W x D x H, 562-568 x 403 x 388 mm
- Packing dimensions: W x D x H, 490 x 320 x 620 mm
- Weight incl. packing: 12,25 kg

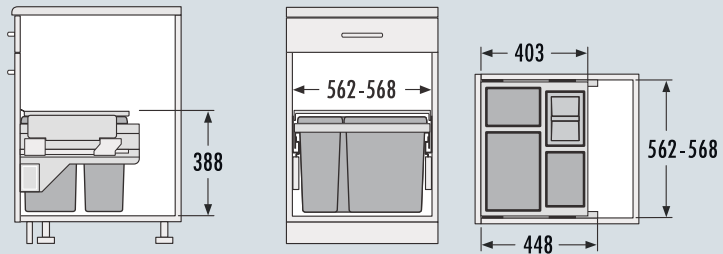

- Separation: 3-fold
- Inner bins: 1 x 20 l, 2 x 10 l, Total capacity 40 l
1 x Lid 10 l
- Type of installation: side-wall-mounted, self-adjusting to 16 - 19 mm side walls mounts also under sink
- Slides: covered, dampened slides with self-closing device
- System-depth: 448 mm
- Sheet metal system Lid
- Colour: Metal parts sheet steel silver-coloured,
- Product dimensions: W x D x H, 562-568 x 332 x 370 mm
- Packing dimensions: W x D x H, 490 x 320 x 620 mm
- Weight incl. packing: 12,2 kg

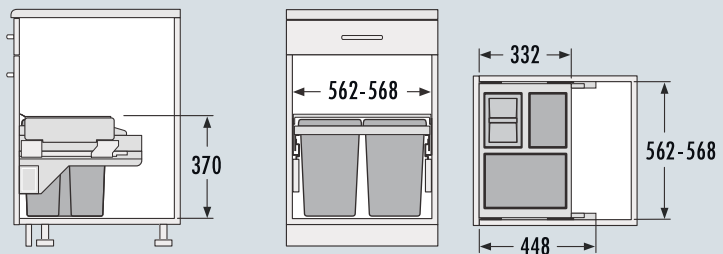

- Separation: 4-fold
- Inner bins: 1 x 15 l, 3 x 7 l, Total capacity 36 l
1 x Lid 7 l
- Type of installation: side-wall-mounted, self-adjusting to 16 - 19 mm side walls
- Slides: covered, dampened slides with self-closing device
- System-depth: 448 mm
- Sheet metal system Lid
- Colour: Metal parts silver coloured
- Product dimensions: W x D x H, 562-568 x 403 x 306 mm
- Packing dimensions: W x D x H, 490 x 320 x 620 mm
- Weight incl. packing: 12,2 kg

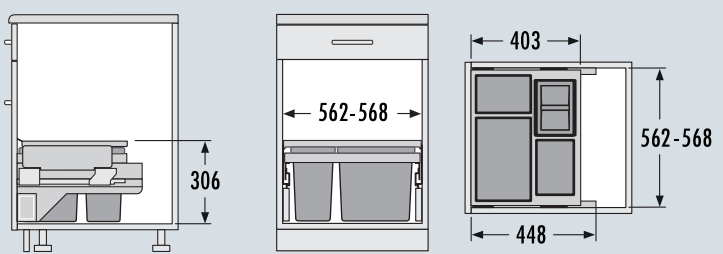

Slide



Für Schränke mit 600 mm Breite mit Frontauszug
For front-mount-door cabinets of 600 mm width

Cargo Basic

Hailo AS Cargo Basic 600 24/10/10/10/D

3609601



- Trennung: 4-fach
- Abfalleimer: 1 x 24 l, 3 x 10 l, Gesamtvolumen 54 l, 1 x Behälterdeckel 10 l
- Montageart: Seitenwandmontage, selbstjustierend 16 - 19 mm
- **Auszugsschienen: Überauszug mit Selbsteinzug**
- Systemtiefe: 403 mm
- Metallsystemdeckel
- Farbe: Metallteile Stahlblech silberfarben
- Produkt-Maße: B x T x H, 562-568 x 403 x 387 mm
- Verpackungsmaße: B x T x H, 490 x 320 x 620 mm
- Gewicht mit Verpackung: 13 kg

Hailo Kick and Go

Fußhebel

3691301

3691401

3691501



3691301 Fußhebel "Kick and go" für unteren Schubkasten
3691401 Fußhebel "Kick and go" für Cargo Basic, 3609
3691501 Fußhebel "Kick and go"
für Euro Cargo 3614 und 3619- 451+601

Die Cargos fahren per Fußdruck heraus

Mehr Infos auf Seite 202

Hailo Libero

Türöffner

3697101



Hailo Libero – Hands Free Opener

Die Öffnungsunterstützung von Hailo für ein automatisches, komfortables Öffnen aller Abfalltrennsysteme mit Frontanbindung und aller Auszugssysteme.

Ausführliche Beschreibung Seite 198

Kann in Verbindung mit Metalltüren, gerahmten Metalltüren und Metall-Sockeln zu Funktionsstörungen führen.

- Separation: 4-fold
- Inner bins: 1 x 24 l, 3 x 10 l, Total capacity 54 l
1 x Lid 10 l
- Type of installation: side-wall-mounted, self-adjusting to 16 - 19 mm side walls
- Slides: **non-dampened over travel slides**
- System-depth: 403 mm
- Sheet metal system Lid
- Colour: Metal parts silver-coloured
- Product dimensions: W x D x H, 562-568 x 403 x 387 mm
- Packing dimensions: W x D x H, 490 x 320 x 620 mm
- Weight incl. packing: 13 kg

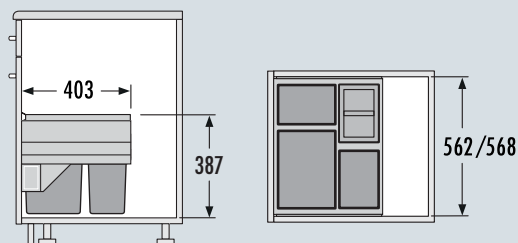

Foot Pedal

- 3691301 Foot Pedal "Kick and go" for lower drawer
- 3691401 Foot Pedal "Kick and go" for Cargo Basic
- 3691501 Foot Pedal "Kick and go" for Euro Cargo 45 & Euro Cargo 60

The Cargo leaves the cabinet by a light toe-kick – hands-free

More information page 202

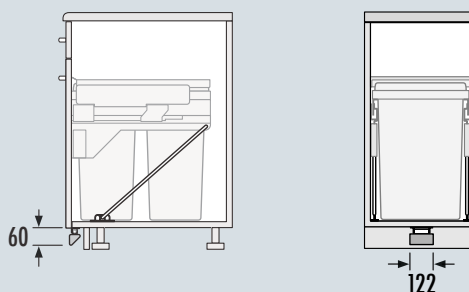

60 cm

Door Opener

Hailo „Libero“ – Hands Free Opener

Hailo's electronic front-mount-door and drawer-opener „Libero“ offers an automatic, comfortable hands-free opening of all waste-recycling-systems with attached door-panel and of any common, also damped, drawer-mounted systems.

With 2-pin Euro-Plug, 230 V, IP 4.1 certified

More information page 198

If installed behind a door-panel with a metal frame, or behind a metal cabinet-front, or above a metal plinth, malfunctions may occur.

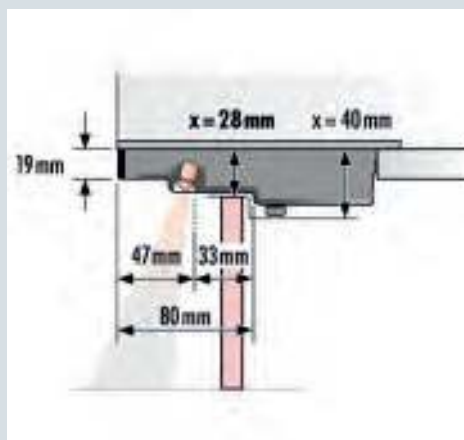



Übrigens, wussten Sie, ...

dass die Marke Hailo in Deutschland einen Bekanntheitsgrad von etwa 53% besitzt?

By the way, did you know...

that the Hailo brand enjoys a recognition factor of approx. 53% in Germany?

Inset



Einsatz für Schränke ab 600 mm Breite mit Frontauszug
For cabinets with drawer, from 600 mm width



60 cm

Inset



Einsatz für Schränke ab 600 mm Breite mit Frontauszug
For cabinets with drawer, from 600 mm width

Triple XL 60

Hailo AS Triple XL 600 24/10/10/10/D



- Trennung: 4-fach
- Abfalleimer: 1 x 24 l, 3 x 10 l, Gesamtvolumen 54 l, 1 x Behälterdeckel 10 l
- **Montageart: Schubkastenmontage,** Seitenwandstärke 16 bis 19 mm
- Schubkasten Nenntiefe \geq 420 mm
- Metallsystemdeckel
- Farbe: Metallteile silberfarben
- Produkt-Maße: T x H, 400 x 378 mm
- Verpackungsmaße: B x T x H, 435 x 315 x 575 mm
- Gewicht mit Verpackung: 9,5 kg

Triple XL 60

Hailo AS Triple XL 600 30/30/D



- Trennung: 2-fach
- Abfalleimer: 2 x 30 l, Gesamtvolumen 60 l, 1 x Behälterdeckel 30 l
- **Montageart: Schubkastenmontage,** Seitenwandstärke 16 bis 19 mm
- Schubkasten Nenntiefe \geq 420 mm
- Metallsystemdeckel
- Farbe: Metallteile silberfarben
- Produkt-Maße: T x H, 400 x 430 mm
- Verpackungsmaße: B x T x H, 435 x 315 x 575 mm
- Gewicht mit Verpackung: 10,8 kg

Triple XL 60

Hailo AS Triple XL 600 30/13/13/D



- Trennung: 3-fach
- Abfalleimer: 1 x 30 l, 2 x 13 l, Gesamtvolumen 56 l, 1 x Behälterdeckel 13 l
- **Montageart: Schubkastenmontage,** Seitenwandstärke 16 bis 19 mm
- Schubkasten Nenntiefe \geq 420 mm
- Metallsystemdeckel
- Farbe: Metallteile silberfarben
- Produkt-Maße: T x H, 400 x 430 mm
- Verpackungsmaße: B x T x H, 435 x 315 x 575 mm
- Gewicht mit Verpackung: 11 kg



Mittlere Variante
Medium Type

- Separation: 4-fold
- Inner bins: 1 x 24 l, 3 x 10 l, Total capacity 54 l, 1 x Lid 10 l
- **Type of installation: inside available drawer, side-wall-thickness 16 - 19 mm**
- Nominal drawer-depth ≥ 420 mm
- Sheet metal system Lid
- Colour: Metal parts silver-coloured
- Product dimensions: D x H, 400 x 378 mm
- Packing dimensions: W x D x H, 435 x 315 x 575 mm
- Weight incl. packing: 9,5 kg

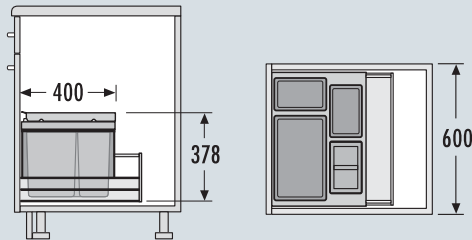

Hohe Variante
Tall Type

- Separation: 2-fold
- Inner bins: 2 x 30 l, Total capacity 60 l, 1 x Lid 30 l
- **Type of installation: inside available drawer, side-wall-thickness 16 - 19 mm**
- Nominal drawer-depth ≥ 420 mm
- Sheet metal system Lid
- Colour: Metal parts silver-coloured
- Product dimensions: D x H, 400 x 430 mm
- Packing dimensions: W x D x H, 435 x 315 x 575 mm
- Weight incl. packing: 10,8 kg

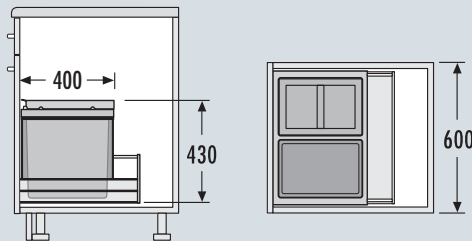

Hohe Variante
Tall Type

- Separation: 3-fold
- Inner bins: 1 x 30 l, 2 x 13 l, Total capacity 56 l, 1 x Lid 13 l
- **Type of installation: inside available drawer, side-wall-thickness 16 - 19 mm**
- Nominal drawer-depth ≥ 420 mm
- Sheet metal system Lid
- Colour: Metal parts silver-coloured
- Product dimensions: D x H, 400 x 430 mm
- Packing dimensions: W x D x H, 435 x 315 x 575 mm
- Weight incl. packing: 11 kg

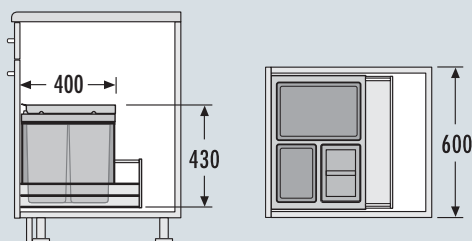

60 cm

Inset



Einsatz für Schränke ab 600 mm Breite mit Frontauszug For cabinets with drawer, from 600 mm width

XXL 60



3630601

Hailo AS XXL 600 18/D/8,5/8,5/P/P

- Trennung: 3-fach
- Abfalleimer: 1 x 18 l, 2 x 8,5 l, Gesamtvolumen 35 l, 1x Behälterdeckel 18 l, 2 x Putzmittelkorb 4,1 l
- **Montageart: Schubkastenmontage,** Seitenwandstärke 16 bis 19 mm
- Schubkasten Nenntiefe \geq 450 mm
- Metallsystemdeckel
- Farbe: Metallteile silberfarben
- Produkt-Maße: T x H, 433 x 330 mm
- Verpackungsmaße: B x T x H, 455 x 315 x 580 mm
- Gewicht mit Verpackung: 9,5 kg



Separato K



3620611

Hailo AS Separato K 600 18/8/8/D

- Trennung: 3-fach
- Abfalleimer: 1 x 18 l, 2 x 8 l, Gesamtvolumen 34 l, 1 x Behälterdeckel 8 l
- **Montageart: Schubkastenmontage,** Seitenwandstärke 16 bis 19 mm
- Schubkasten Nenntiefe \geq 500 mm
- Kunststoff-Deckel herausziehbar, Seitenwandmontage
- Farbe: Kunststoffteile hellgrau
- Produkt-Maße: B x T x H, 557 x 491 x 340 mm
- Verpackungsmaße: B x T x H, 570 x 510 x 275 mm
- Gewicht mit Verpackung: 4,7 kg





Niedrige Variante
Low Type

- Separation: 3-fold
- Inner bins: 1 x 18 l, 2 x 8.5 l, Total capacity 35 l,
1 x Lid 18 l, 2 x Cleansers basket 4.1 l
- **Type of installation: inside available drawer,**
side-wall-thickness 16 - 19 mm
- Nominal drawer-depth ≥ 450 mm
- Sheet metal system Lid
- Colour: Metal parts silver-coloured
- Product dimensions: D x H, 433 x 330 mm
- Packing dimensions: W x D x H, 455 x 315 x 580 mm
- Weight incl. packing: 9,5 kg

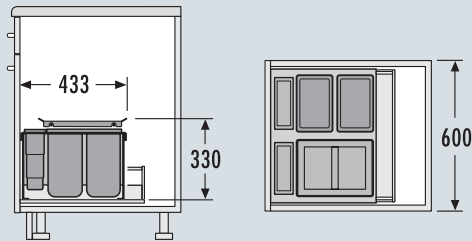

Mittlere Variante
Medium Type

- Separation: 3-fold
- Inner bins: 1 x 18 l, 2 x 8 l, Total capacity 34 l
1 x Lid 8 l
- **Type of installation: inside available drawer,**
side-wall-thickness 16 - 19 mm
- Nominal drawer-depth ≥ 500 mm
- Plastic-lid single extension, sidewall-mounted
- Colour: Plastic parts light-grey
- Product dimensions: W x D x H, 557 x 491 x 340 mm
- Packing dimensions: W x D x H, 570 x 510 x 275 mm
- Weight incl. packing: 4,7kg

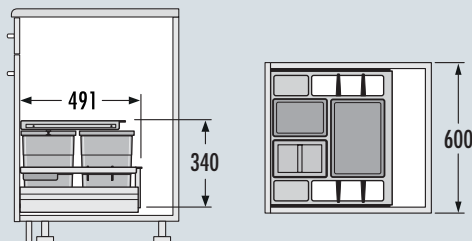

60 cm



Übrigens, wussten Sie, ...

dass Hailo Einbau-Abfallsammler
ausnahmslos in Deutschland
hergestellt werden?

By the way, did you know...

that Hailo built-in waste
separation systems are exclusively
manufactured in Germany?

Inset



Einsatz für Schränke ab 800 mm Breite mit Frontauszug
For cabinets with drawer, from 800 mm width



80 cm

Inset



Einsatz für Schränke ab 800 mm Breite mit Frontauszug For cabinets with drawer, from 800 mm width

XXL 80

Hailo AS XXL 800 18/D/18/D/12/P/P/P

3630801



- Trennung: 3-fach
- Abfalleimer: 2 x 18 l, 1 x 12 l, Gesamtvolumen 48 l, 2 x Behälterdeckel 18 l, 3 x Putzmittelkorb 4,1 l
- **Montageart: Schubkastenmontage,** Seitenwandstärke 16 bis 19 mm
- Schubkasten Nenntiefe \geq 450 mm
- Farbe: Metallteile silberfarben
- Produkt-Maße: T x H, 433 x 300 mm
- Verpackungsmaße: B x T x H, 760 x 275 x 455 mm
- Gewicht mit Verpackung: 9 kg

Triple XL 80

Hailo AS Triple XL 800 30/30/D/19

3631801



- Trennung: 3-fach
- Abfalleimer: 2 x 30 l, 1 x 19 l, Gesamtvolumen 79 l, 1 x Behälterdeckel 30 l
- **Montageart: Schubkastenmontage,** Seitenwandstärke 16 bis 19 mm
- Schubkasten Nenntiefe \geq 420 mm
- Metallsystemdeckel
- Farbe: Metallteile silberfarben
- Produkt-Maße T x H, 400 x 430 mm
- Verpackungsmaße: B x T x H, 785 x 425 x 330 mm
- Gewicht mit Verpackung: 13 kg



Niedrige Variante
Low Type

- Separation: 3-fold
- Inner bins: 2 x 18 l, 1 x 12 l, Total capacity 48 l
2 x Lid 18 l, 3 x Cleanser basket 4.1 l
- **Type of installation: inside available drawer,**
side-wall-thickness 16 - 19 mm
- Nominal drawer-depth ≥ 450 mm
- Colour: Metal parts silver-coloured
- Product dimensions: D x H, 433 x 300 mm
- Packing dimensions: W x D x H, 760 x 275 x 455 mm
- Weight incl. packing: 9 kg

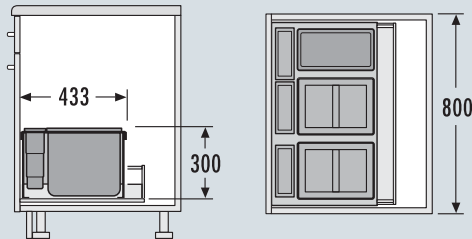

Hohe Variante
Tall Type

- Separation: 3-fold
- Inner bins: 2 x 30 l, 1 x 19 l, Total capacity 79 l
2 x Lid 30 l
- **Type of installation: inside available drawer,**
side-wall-thickness 16 - 19 mm
- Nominal drawer-depth ≥ 420 mm
- Sheet metal system Lid
- Colour: Metal parts silver-coloured
- Product dimensions: D x H, 400 x 430 mm
- Packing dimensions: W x D x H, 785 x 425 x 330 mm
- Weight incl. packing: 13 kg

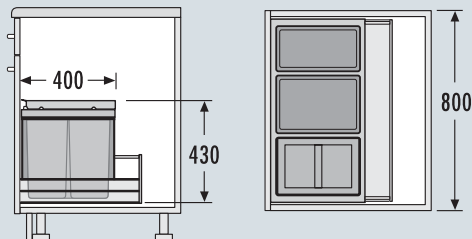

80 cm

Übrigens, wussten Sie, ...



dass Hailo Einbautechnik weltweit
in über 80 Länder exportiert?

By the way, did you know...

that Hailo Built-In Technology
exports to more than 80 countries
around the world?

Inset



Einsatz für Schränke ab 900 mm Breite mit Frontauszug
For cabinets with drawer, from 900 mm width



90 cm

Inset



Einsatz für Schränke ab 900 mm Breite mit Frontauszug For cabinets with drawer, from 900 mm width

XXL 90



Hailo AS XXL 900 18/D/18/D/12/12/P/P/U/U

- Trennung: 4-fach
- Abfalleimer: 2 x 18 l, 2 x 12 l, Gesamtvolumen 60 l, 2 x Behälterdeckel 18 l, 2 x Putzmittelkorb 4,1 l, 2 x Utensiliendepot 0,7 l
- **Montageart: Schubkastenmontage,** Seitenwandstärke 16 bis 19 mm
- Schubkasten Nenntiefe \geq 450
- Farbe: Metallteile silberfarben
- Produkt-Maße: T x H, 433 x 300 mm
- Verpackungsmaße: B x T x H, 860 x 275 x 455 mm
- Gewicht mit Verpackung: 10,2 kg



Triple XL 90



Hailo AS Triple XL 900 30/30/30/D

- Trennung: 3-fach
- Abfalleimer: 3 x 30 l, Gesamtvolumen 90 l, 1 x Behälterdeckel 30 l
- **Montageart: Schubkastenmontage,** Seitenwandstärke 16 bis 19 mm
- Schubkasten Nenntiefe \geq 420 mm
- Metallsystemdeckel
- Farbe: Metallteile silberfarben
- Produkt-Maße: T x H, 400 x 430 mm
- Verpackungsmaße: B x T x H, 875 x 425 x 330 mm
- Gewicht mit Verpackung: 14 kg



Triple XL 90



Hailo AS Triple XL 900 30/30/13/13/D

- Trennung: 4-fach
- Abfalleimer: 2 x 30 l, 2 x 13 l, Gesamtvolumen 86 l, 1 x Behälterdeckel 13 l
- **Montageart: Schubkastenmontage,** Seitenwandstärke 16 bis 19 mm
- Schubkasten Nenntiefe \geq 420 mm
- Metallsystemdeckel
- Farbe: Metallteile silberfarben
- Produkt-Maße: T x H, 400 x 430 mm
- Verpackungsmaße: B x T x H, 875 x 425 x 330 mm
- Gewicht mit Verpackung: 14 kg





Niedrige Variante
Low Type

- Separation: 4-fold
- Inner bins: 2 x 18 l, 2 x 12 l, Total capacity 60 l
2 x Lid 18 l, 2 x Cleaners basket 4.1 l,
2 x utensil depot 0.7 l
- **Type of installation: inside available drawer,**
side-wall-thickness 16 - 19 mm
- Nominal drawer-depth ≥ 450 mm
- Colour: Metal parts silver-coloured
- Product dimensions: D x H, 433 x 300 mm
- Packing dimensions: W x D x H, 860 x 275 x 455 mm
- Weight incl. packing: 10,2 kg

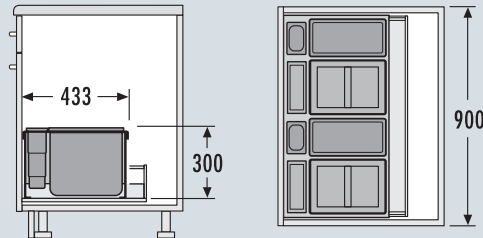

Hohe Variante
Tall Type

- Separation: 3-fold
- Inner bins: 3 x 30 l, Total capacity 90 l
1 x Lid 30 l
- **Type of installation: inside available drawer,**
side-wall-thickness 16 - 19 mm
- Nominal drawer-depth ≥ 420 mm
- Sheet metal system Lid
- Colour: Metal parts silver-coloured
- Product dimensions D x H, 400 x 430 mm
- Packing dimensions: W x D x H, 875 x 425 x 330 mm
- Weight incl. packing: 14 kg

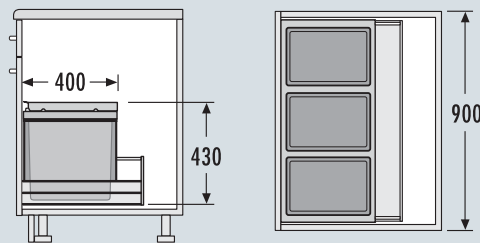

Hohe Variante
Tall Type

- Separation: 4-fold
- Inner bins: 2 x 30 l, 2 x 13 l, Total capacity 86 l
1 x Lid 13 l
- **Type of installation: inside available drawer,**
side-wall-thickness 16 - 19 mm
- Nominal drawer-depth ≥ 420 mm
- Sheet metal system Lid
- Colour: Metal parts silver-coloured
- Product dimensions D x H, 400 x 430 mm
- Packing dimensions: W x D x H, 875 x 425 x 330 mm
- Weight incl. packing: 14 kg

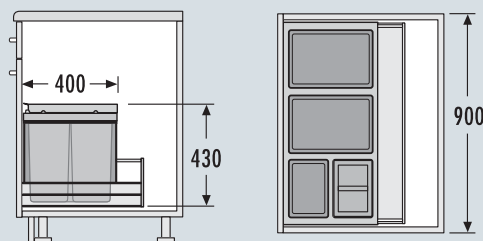

90 cm

Inset



Einsatz für Schränke ab 900 mm Breite mit Frontauszug For cabinets with drawer, from 900 mm width

Separato K

3620901



Hailo AS Separato K 900 18/18/8/8/D/KS

- Trennung: 4-fach
- Abfalleimer: 2 x 18 l, 2 x 8 l, Gesamtvolumen 52 l, 1 x Behälterdeckel 8 l
- **Montageart: Schubkastenmontage,** Seitenwandstärke 16 bis 19 mm
- Schubkasten Nenntiefe \geq 500 mm
- Metallsystemdeckel
- Kehrset
- Farbe: Kunststoffteile hellgrau
- Produkt-Maße: B x T x H, 860 x 491 x 340 mm
- Verpackungsmaße: B x T x H, 880 x 530 x 300 mm
- Gewicht mit Verpackung: 8 kg

Separato K

3620911



Hailo AS Separato K 900 18/18/8/8/D/KS

- Trennung: 4-fach
- Abfalleimer: 2 x 18 l, 2 x 8 l, Gesamtvolumen 52 l, 1 x Behälterdeckel 8 l
- **Montageart: Schubkastenmontage,** Seitenwandstärke 16 bis 19 mm
- Schubkasten Nenntiefe \geq 500 mm
- Kunststoff-Deckel herausziehbar
- Kehrset
- Farbe: Kunststoffteile hellgrau
- Produkt-Maße: B x T x H, 860 x 491 x 340 mm
- Verpackungsmaße: B x T x H, 880 x 530 x 300 mm
- Gewicht mit Verpackung: 7,7 kg



Mittlere Variante
Medium Type

- Separation: 4-fold
- Inner bins: 2 x 18 l, 2 x 8 l, Total capacity 52 l
1 x Lid 8 l
- **Type of installation: inside available drawer,**
side-wall-thickness 16 - 19 mm
- Nominal drawer-depth ≥ 500 mm
- Sheet metal system Lid, silver-coloured, sidewall-mounted
- Dust-pan with brush
- Colour: Plastic parts light-grey, plastic frame
- Product dimensions: W x D x H, 860 x 491 x 340 mm
- Packing dimensions: W x D x H, 880 x 530 x 300 mm
- Weight incl. packing: 8 kg

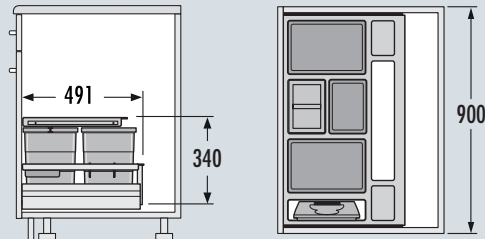

Mittlere Variante
Medium Type

- Separation: 4-fold
- Inner bins: 2 x 18 l, 2 x 8 l, Total capacity 52 l
1 x Lid 8 l
- **Type of installation: inside available drawer,**
side-wall-thickness 16 - 19 mm
- Nominal drawer-depth ≥ 500 mm
- Plastic-lid single extension, sidewall-mounted
- Dust-pan with brush
- Colour: Plastic parts light-grey, plastic frame
- Product dimensions: W x D x H, 860 x 491 x 340 mm
- Packing dimensions: W x D x H, 880 x 530 x 300 mm
- Weight incl. packing: 7,7kg

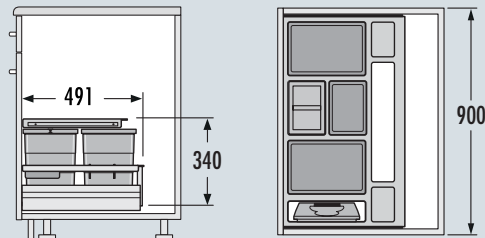

90 cm

Übrigens, wussten Sie, ...

By the way, did you know...

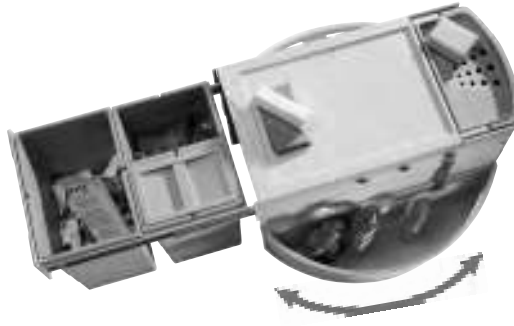

dass der Hailo Rondo das erste ganzheitliche Abfalltrenn- und Ordnungssystem für Eckspülenschränke war und bis heute als das Original schlechthin gilt.

that the Hailo Rondo is the first integrated waste separation and order system for corner sink units and is still regarded as the original today?

Für Diagonal-Eckspülenschränke ab 900 mm Breite
For diagonal door corner-sink-cabinets from 900 mm width



90 cm

Für Diagonal-Eckspülenschränke ab 900 mm Breite For diagonal door corner-sink-cabinets from 900 mm width

Rondo®

Hailo AS Rondo® 18/18/ME

3645121



- Trennung: 2-fach, drehbar
- Abfalleimer: 2 x 18 l, Gesamtvolumen 36 l, 1 x Multifunktionseimer 12 l mit Lochdeckel, 2 x Utensilienschalen
- Montageart: Bodenmontage, 360° drehbar
- **Auszugsschienen: Vollauszug**
- Farbe: Metallteile silberfarben, weiß, Kunststoffteile hellgrau
- Einbau-Maße: B x T x H, 336 x 700 x 351 mm
- Produkt-Maße: Ø 700 mm
- Verpackungsmaße: B x T x H, 680 x 560 x 410 mm
- Gewicht mit Verpackung: 12,5 kg

Rondo®

Hailo AS Rondo® 18/8,5/8,5/D/ME

3646131



- Trennung: 3-fach, drehbar
- Abfalleimer: 1 x 18 l, 2 x 8,5 l, Gesamtvolumen 35 l, 1 x Multifunktionseimer 12 l mit Lochdeckel, 2 x Utensilienschalen, 1 x Behälterdeckel 8,5 l
- Montageart: Bodenmontage, 360° drehbar
- **Auszugsschienen: Vollauszug**
- Farbe: Metallteile silberfarben, weiß, Kunststoffteile hellgrau
- Einbau-Maße: B x T x H, 336 x 700 x 351 mm
- Produkt-Maße: Ø 700 mm
- Verpackungsmaße: B x T x H, 680 x 560 x 410 mm
- Gewicht mit Verpackung: 13 kg

Rondo®

Hailo AS Rondo® 8,5/8,5/8,5/8,5/D/ME

3647141



- Trennung: 4-fach, drehbar
- Abfalleimer: 4 x 8,5 l, Gesamtvolumen 34 l, 1 x Multifunktionseimer 12 l mit Lochdeckel, 2 x Utensilienschalen, 1 x Behälterdeckel 8,5 l
- Montageart: Bodenmontage, 360° drehbar
- **Auszugsschienen: Vollauszug**
- Farbe: Metallteile silberfarben, weiß, Kunststoffteile hellgrau
- Einbau-Maße: B x T x H, 336 x 700 x 351 mm
- Produkt-Maße: Ø 700 mm
- Verpackungsmaße: B x T x H, 680 x 560 x 410 mm
- Gewicht mit Verpackung: 13,1 kg



Niedrige Variante
Low Type

- Separation: 2-fold, swivelling
- Inner bins: 2 x 18 l, Total capacity 36 l, 1 x Multifunctional bucket 12 l with perforated lid, 2 x Utensil-side-baskets
- Type of installation: bottom mounted, Turnable 360°
- **Slides: full extension**
- Colour: Metal parts silver-coloured, white, Plastic parts light grey
- Built-in dimensions: W x D x H, 336 x 700 x 351 mm
- Product dimensions: Ø 700 mm
- Packing dimensions: W x D x H, 680 x 560 x 410 mm
- Weight incl. packing: 12,5 kg

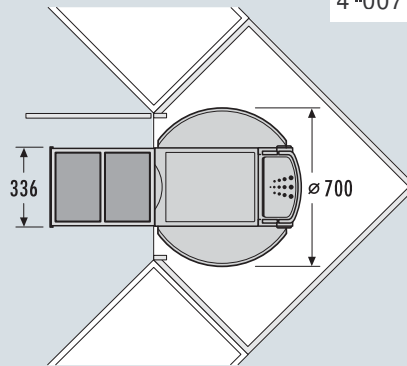
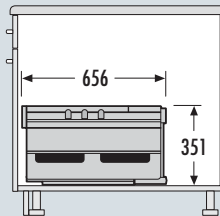

Niedrige Variante
Low Type

- Separation: 3-fold, swivelling
- Inner bins: 1 x 18 l, 2 x 8.5 l, Total capacity 35 l, 1 x Multifunctional bucket 12 l with perforated lid, 2 x Utensil-side-baskets, 1 x Lid 8.5 l
- Type of installation: bottom mounted, Turnable 360°
- **Slides: full extension**
- Colour: Metal parts silver-coloured, white, Plastic parts light grey
- Built-in dimensions: W x D x H, 336 x 700 x 351 mm
- Product dimensions: Ø 700 mm
- Packing dimensions: W x D x H, 680 x 560 x 410 mm
- Weight incl. packing: 13 kg

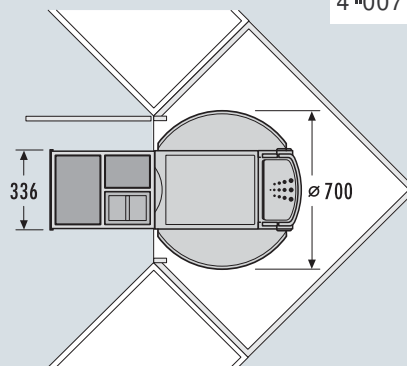
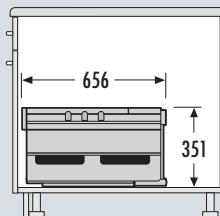

Niedrige Variante
Low Type

- Separation: 4-fold, swivelling
- Inner bins: 4 x 8.5 l, Total capacity 34 l, 1 x Multifunctional bucket 12 l with perforated lid, 2 x Utensil-side-baskets, 1 x Lid 8.5 l
- Type of installation: bottom mounted, Turnable 360°
- **Slides: full extension**
- Colour: Metal parts silver-coloured, white, Plastic parts light grey
- Built-in dimensions: W x D x H, 336 x 700 x 351 mm
- Product dimensions: Ø 700 mm
- Packing dimensions: W x D x H, 680 x 560 x 410 mm
- Weight incl. packing: 13,1 kg

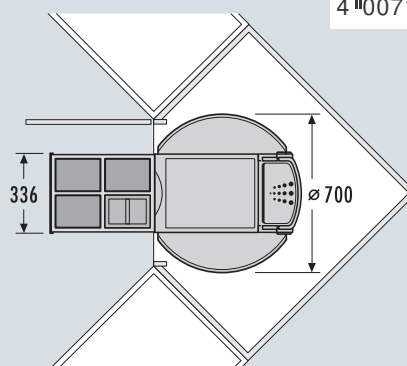
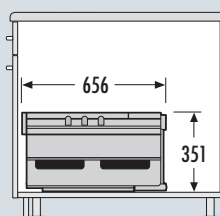

90 cm

Für Diagonal-Eckspülenschränke ab 900 mm Breite For diagonal door corner-sink-cabinets from 900 mm width

Rondo® Comfort



Hailo AS Rondo® Comfort 20/20/KS/ME

3645221



- Trennung: 2-fach, drehbar
- Abfalleimer: 2 x 20 l, Gesamtvolumen 40 l, 1 x Multifunktionseimer 12 l mit Lochdeckel, 2 x Utensilienschalen
- Montageart: Bodenmontage, 360° drehbar
- **Auszugsschienen: gedämpfter Selbsteinzug**
- Mit integriertem Kehr-Set, Kunststoff rot
- Farbe: Metallteile silberfarben, weiß, Kunststoffteile hellgrau
- Einbau-Maße: B x T x H, 336 x 700 x 406 mm
- Produkt-Maße: Ø 700 mm
- Verpackungsmaße: B x T x H, 680 x 620 x 410 mm
- Gewicht mit Verpackung: 14,0 kg



Rondo® Comfort



Hailo AS Rondo® Comfort 20/10/10/D/KS/ME

3646231



- Trennung: 3-fach, drehbar
- Abfalleimer: 1 x 20 l, 2 x 10 l, Gesamtvolumen 40 l, 1 x Multifunktionseimer 12 l mit Lochdeckel, 2 x Utensilienschalen, 1x Behälterdeckel 10 l
- Montageart: Bodenmontage, 360° drehbar
- **Auszugsschienen: gedämpfter Selbsteinzug**
- Mit integriertem Kehr-Set, Kunststoff rot
- Farbe: Metallteile silberfarben, weiß, Kunststoffteile hellgrau
- Einbau-Maße: B x T x H, 336 x 700 x 406 mm
- Produkt-Maße: Ø 700 mm
- Verpackungsmaße: B x T x H, 680 x 620 x 410 mm
- Gewicht mit Verpackung: 15 kg



Schlauchbrausenabweiser

3693001



Metallbügel zum Einbau in Spülenunterschänke zur gezielten Schlauchführung.

- Verpackungseinheit: 5
- Verpackungsmaße: B x T x H, 445 x 190 x 85 mm



**Hohe Variante
Tall Type**

- Separation: 2-fold, swivelling
- Inner bins: 2 x 20 l, Total capacity 40 l
1 x Multifunctional bucket 12 l with perforated lid,
2 x Utensil-side-baskets
- Type of installation: bottom mounted, Turnable 360°
- **Slides: dampened slides with self-closing device**
- With dust-pan and a brush, Plastic red
- Colour: Metal parts silver-coloured, white,
Plastic parts light grey
- Built-in dimensions: W x D x H, 336 x 700 x 406 mm
- Product dimensions: Ø 700 mm
- Packing dimensions: W x D x H, 680 x 620 x 410 mm
- Weight incl. packing: 14,0 kg

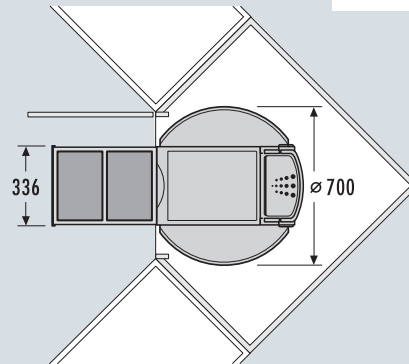
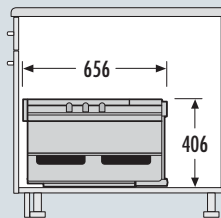

**Hohe Variante
Tall Type**

- Separation: 3-fold, swivelling
- Inner bins: 1 x 20 l, 2 x 10 l, Total capacity 40 l,
1 x Multifunctional bucket 12 l with perforated lid,
2 x Utensil-side-baskets, 1x Lid 10 l
- Type of installation: bottom mounted, Turnable 360°
- **Slides: dampened slides with self-closing device**
- With dust-pan and a brush, Plastic red
- Colour: Metal parts silver-coloured, white,
Plastic parts light grey
- Built-in dimensions: W x D x H, 336 x 700 x 406 mm
- Product dimensions: Ø 700 mm
- Packing dimensions: W x D x H, 680 x 620 x 410 mm
- Weight incl. packing: 15 kg

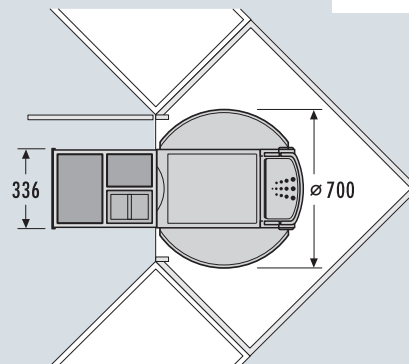
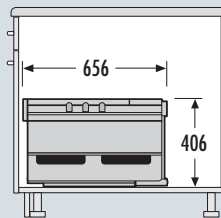

90 cm

Wall-Bracket for Flex-Hose

**Wire bracket for sink-cabinets,
for rerouting of flexible hoses.**

- Packing unit: 5 each per carton
- Packing dimensions: W x D x H, 445 x 190 x 85 mm



Ordnungssysteme

Organizer



Pantry Box		Seite/ Page 161 - 165
Orga Board		Seite/ Page 166 - 167
On Top System		Seite/ Page 166 - 167
Secco		Seite/ Page 169 - 173
Deposito light		Seite/ Page 175 - 177
Deposito Kippsystem Deposito Tilting System		Seite/ Page 178 - 179
Deposito Regalsystem Deposito Rack System		Seite/ Page 181 - 183
Vario		Seite/ Page 185 - 189
Carry		Seite/ Page 191 - 193



Übrigens, wussten Sie, ...

dass Hailo im Verzeichnis „Marken des Jahrhunderts“ neben anderen 300 Premiummarken vertreten ist?

By the way, did you know...

that Hailo is amongst 300 premium brands listed in the “Brands of the Century” guide?

Hailo Pantry-Box.

Hailo Pantry-Box.



Inset



Einsatz für Schränke mit 600 mm Breite und Frontauszug For cabinets with drawer, from 600 mm width

Hailo Pantry Box



Gemüse, Backwaren etc. werden ideal gelagert und sind sofort zur Hand.

Eine formstabile, auswischbare Kunststoffbox ist die Basis der neuen Hailo Pantry Box.

Ein eingelegter Kunststoffboden mit Abtropf- und Lüftungsschlitzen sorgt für entsprechend geeignete Lagerung von Gemüse. Durch einen gehärteten Glas-Schiebedeckel sind die Lebensmittel hygienisch abgedeckt und dennoch sichtbar.

Passend auf alle 60er Zargen und Schubkästen der Hersteller Blum/Grass/Hettich – Nenntiefe 500 mm

Hailo Pantry Box



- Für Unterschränke 600 mm Breite
- Inklusive einer Tragebox
- Inklusive Holzrost für Backwaren und Kunststoffrost für Gemüse
- **Montageart: Schubkasteneinsatz für alle handelsüblichen Schubkastensysteme** (Seitenwandstärken 16 bis 19 mm)
- Farbe: Kunststoffteile weiß
- Produkt-Maße: T x H, 491 x 232 mm
- Schubkasten Nenntiefe: 500 mm
- Verpackungsmaße: B x T x H, 730 x 600 x 330 mm
- Gewicht mit Verpackung: 9,6 kg

Hailo Pantry Box

1127809



Tragebox

- Praktische Tragebox aus Lebensmittelverträglichem Kunststoff
- Farbe: weiß
- Produkt-Maße: B x T x H, 242 x 242 x 181 mm
- Gewicht: 550 g

Vegetables, potatoes or bakery products are ideally stored - for immediate access.

The stable, easy-to-clean plastic box is the base of the new Hailo Pantry Box.

Covered by an innovative Safety-Glass Sliding Lid it stores and covers the food hygienically and visibly. The included, removable plastic grid with drainage- and ventilation-slots ensures a suitable, convenient storage of vegetables.

Fits into any 60 cm drawer-system made by Blum, Grass, Hettich, of nominal depth NT 500 mm.



- For 600 mm wide drawer-cabinets
- Including Carry-Box (transportable plastic container with handle)
- Including wooden grid for bakery products and plastic grid for vegetables
- Type of installation: for any common standard-drawers in boxed kitchen- and base-cabinets (with sidewall thickness from 16 to 19mm)
- Plastic parts white
- Product dimensions: D x H, 491 x 232 mm
- Nominal depth 500 mm
- Packing dimensions: W x D x H, 730 x 600 x 330 mm
- Weight incl. packing 9,6 kg

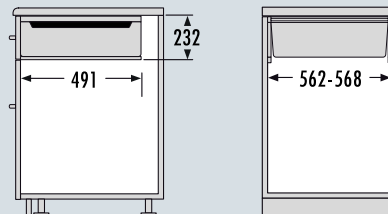

Carry Box

- Practical transportable Carry-Box (accessories), food-save plastic
- White
- Product dimensions: W x D x H, 242 x 242 x 181 mm
- Weight: 550 g



Inset



Einsatz für Schränke mit 600 mm Breite und Frontauszug For cabinets with drawer, from 600 mm width

Hailo Pantry Box



Hailo Pantry Box Erweiterung

Die Lebensmittelschublade mit praktischen herausnehmbaren Behältern aus massivem Echtholz.

Eine formstabile, auswischbare Kunststoffbox ist auch hier die Basis der Hailo Pantry Box Erweiterung. Ein eingelegter Holztablar trägt die 7 Holzbehälter (4 große und 3 kleine Behälter). Bestehend aus lebensmittelecht lackiertem Holz eignen sich die Behälter zur Lagerung und Einteilung von losen/verpackten trockenen Lebensmittel wie Müsli, Nüsse, Nudeln, Reis, Backzutaten usw. Durch einen gehärteten Glas-Schiebedeckel sind die Lebensmittel hygienisch abgedeckt und dennoch sichtbar.

Passend auf alle 60er Zargen und Schubkästen der Hersteller Blum/Grass/Hettich – Nenntiefe 500 mm

- Für Unterschränke 600 mm Breite
- Inklusive Holztablar und 7 Behälter aus lackiertem Echtholz
- **Montageart: Schubkasteneinsatz für alle handelsüblichen Schubkastensysteme** (Seitenwandstärke 16 bis 19 mm)
- Produktmaße: T x H, 491 x 232 mm
- Fassungsvermögen: großer Behälter 1,7 l, kleiner Behälter 1,3 l
- Schubkasten Nenntiefe: 500 mm
- Verpackungsmaße B x T x H: 730 x 600 x 330 mm
- Gewicht mit Verpackung: 12,3 kg

Hailo Pantry Box Add on

The food drawer with useful removable containers made of solid genuine wood.

The stable, easy-to-clean plastic box is also the base for the Hailo Pantry Box add on.

Covered by an innovative Safety-Glass Sliding Lid it stores and covers the food hygienically and visibly.

An inserted wooden shelf carries the seven wooden boxes (four large and three small ones).

Made from food safe varnished wood, the boxes are suitable for the storage and division of loose and packed dry groceries, such as cereal, nuts, pasta, rice, baking ingredients etc.

Fits into any 60 cm drawer-system made by Blum, Grass, Hettich, of nominal depth NT 500 mm



- For 600 mm wide drawer-cabinets
- Inclusive wooden shelf and seven boxes of varnished genuine wood
- Type of installation: for any common standard-drawers in boxed kitchen- and base-cabinets (with sidewall thickness from 16 to 19 mm)
- Product dimensions: D x H, 491 x 232 mm
- Capacity: large box: 1,7 l; small box: 1,3 l
- Nominal depth 500 mm
- Packing dimensions: W x D x H, 730 x 600 x 330 mm
- Weight incl. packing 12,3 kg

Einsatz für Schränke mit 600 mm Breite und Frontauszug For cabinets with drawer, from 600 mm width

Hailo Orga Board



3100601

Lange Variante, Nr. 3100-60, 420 mm tief

- Produkt-Maße: B x T x H, 568 x 460 x 60 mm
- Verpackungsmaße: B x T x H, 581 x 470 x 71 mm
- Gewicht mit Verpackung 6,5 kg
- für 16 mm Seitenwandstärke



3101601

Kurze Variante, Nr. 3101-60 nur 197 mm tief für Spülenauszüge.

Lieferung mit 2 Hailo Kitty, Universalboxen

- Produkt-Maße: B x T x H, 568 x 200 x 60 mm
- Verpackungsmaße: B x T x H, 581 x 217 x 210 mm
- Gewicht mit Verpackung 5 kg
- für 16 mm Seitenwandstärke

Hailo On Top System



3205601

Hailo On Top System

- Behälter: 2 x 4 l, hellgrün/weiß,
2 x Behälterdeckel 4 l
- Tablarauszug aus Kunststoff ausziehbar, Teilauszug
- Farbe: Kunststoffteile hellgrau
- Auszug/Produkt-Maße:
B x T x H, 562 x 400 x 109 mm
- Verpackungsmaße: B x T x H, 570 x 410 x 140 mm
- Gewicht mit Verpackung: 3,7 kg

ideal kombinierbar mit allen 60er-Slide-Systemen
(3610621, -641, -661, -671, -681)

Big Type P/N 3100-60 is 420 mm deep

- Product dimensions: W x D x H, 568 x 460 x 60 mm
- Packing dimensions: W x D x H, 581 x 470 x 71 mm
- Weight incl. packing 6,5 kg
- for 16 mm sidewall thickness

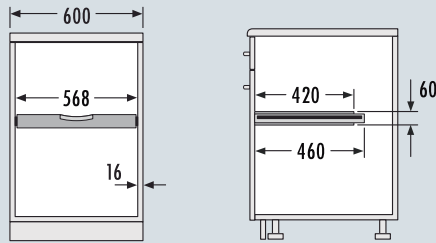

Short Type P/N 3101-60 is 197 mm deep

and comes with
2 Hailo "Kitty" boxes included

- Product dimensions: W x D x H, 568 x 200 x 60 mm
- Packing dimensions: W x D x H, 581 x 217 x 210 mm
- Weight incl. packing 5 kg
- for 16 mm Sidewall thickness

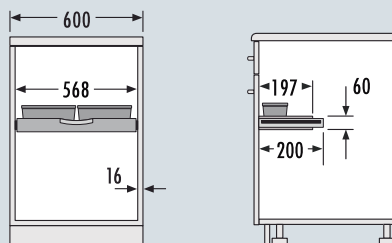

- Container: 2 x 4 l light green/white, 2 x Lid 4 l
- Type of installation: For any common drawer
- Plastic-Pullout single extension lid
- Plastic parts light grey
- Pullout/Product Dimensions:
B x T x H, 562 x 400 x 109 mm
- Packing dimensions: W x D x H, 570 x 410 x 140 mm
- Weight incl. packing 3,7 kg

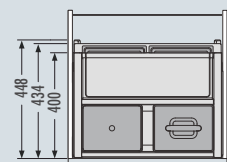
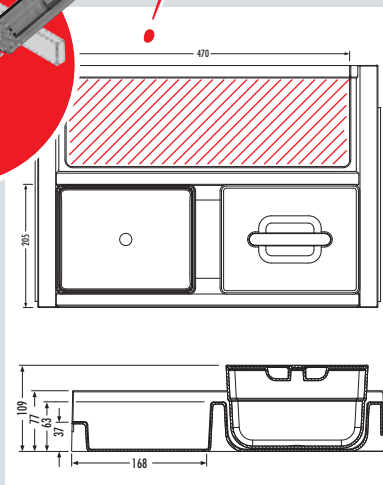
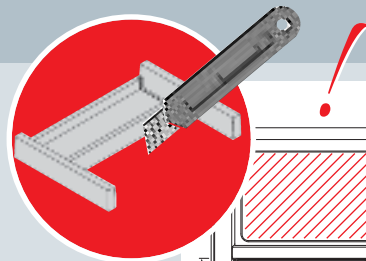

Ideally combinable with all slide systems of 600 mm width
(3610621, -641, -661, -671, -681)



Übrigens, wussten Sie, ...

dass die Marke Hailo in Deutschland einen Bekanntheitsgrad von etwa 53% besitzt?

By the way, did you know...

that the Hailo brand enjoys a recognition factor of approx. 53% in Germany?

Gut betucht.
Well-to do.



Secco S

Handtuchhalter

3151001



- Modell: Secco S
- Haltestangen: 1
- Produkt-Maße: 450 x 200 x 20 mm
- Haltestangen Länge: 450 mm
- Material/Farbe: Kunststoff/hellgrau
- Gewicht: 0,4 kg
- Verpackungsmaße: B x T x H, 460 x 210 x 30 mm

Handtuchhalter

Handtuchhalter mit 2 Haltestangen

3142901



- Modell: Handtuchhalter 2-teilig
- Ausziehstangen: 2
- Produkt-Maße: B x T x H, 119 x 86 x 430 mm
- Ausziehbar von - bis: 430-755 mm
- Metall-/Kunststoffteile weiß
- Gewicht Verpackungseinheit: 4,5 kg
- Verpackungsmaße: B x T x H, 460 x 320 x 130 mm
- **Verpackungseinheit: 10**

Handtuchhalter

Handtuchhalter mit 3 Haltestangen

3143901



- Modell: Handtuchhalter 3-teilig
- Ausziehstangen: 3
- Produkt-Maße: B x T x H, 168 x 86 x 430 mm
- Ausziehbar von - bis: 430-755 mm
- Metall-/Kunststoffteile weiß
- Gewicht Verpackungseinheit: 6,0 kg
- Verpackungsmaße: B x T x H, 465 x 420 x 130 mm
- **Verpackungseinheit: 10**

Towel Rail

- Model: Secco S
- Holding bars: 1 arms
- Product dimensions: 450 x 200 x 20 mm
- Holding bar, length: 450 mm
- Material/Colour: Plastic/light-grey
- Weight: 0,4 kg
- Packing dimensions: W x D x H, 460 x 210 x 30 mm

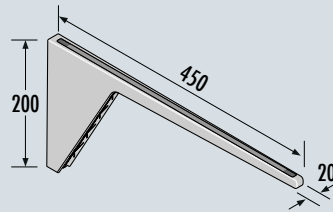

Towel Rail with 2 bars

- Model: Towel rail, double rail
- Pull-out bars: 2 arms
- Product dimensions: W x D x H, 119 x 86 x 430 mm
- To be extended from - to: 430-755 mm
- Metal/plastic parts white
- Weight packing unit: 4,5 kgs
- Packing dimensions: W x D x H, 460 x 320 x 130 mm
- Packing unit: 10

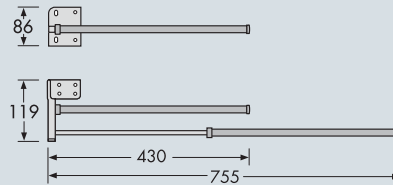

Towel Rail with 3 bars

- Model: Towel rail, triple rail
- Pull-out bars: 3 arms
- Product dimensions: W x D x H, 168 x 86 x 430 mm
- To be extended from - to: 430-755 mm
- Metal/plastic parts white
- Weight packing unit: 6,0 kgs
- Packing dimensions: W x D x H, 465 x 420 x 130 mm
- Packing unit: 10

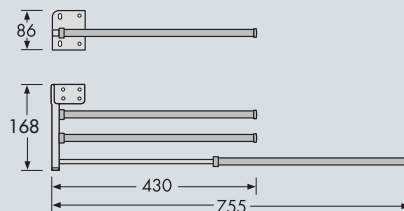

Secco

Handtuchhalter mit 2 Haltestangen



- Modell: Secco mit 2 Haltestangen
- Haltestangen: 2
- Produkt-Maße: B x T x H, 122 x 457 x 30 mm
- Metall-/Kunststoff: Alu/dunkelgrau
- Gewicht: 300 g
- Verpackungsmaße: B x T x H, 455 x 155 x 80 mm

Secco

Handtuchhalter mit 3 Haltestangen



- Modell: Secco mit 3 Haltestangen
- Haltestangen: 3
- Produkt-Maße: B x T x H, 184 x 457 x 30 mm
- Metall-/Kunststoff: Alu/dunkelgrau
- Gewicht: 420 g
- Verpackungsmaße: B x T x H, 455 x 155 x 80 mm

Towel Rail with 2 bars

- Model: Secco with 2 bars
- Holding bars: 2 arms
- Product dimensions: W x D x H, 122 x 457 x 30 mm
- Metal/plastic: alu/dark-grey
- Weight: 300 g
- Packing dimensions: W x D x H, 455 x 155 x 80 mm

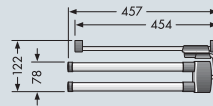
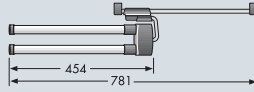

4 007126 313201

Towel Rail with 3 bars

- Model: Secco with 3 bars
- Holding bars: 3 arms
- Product dimensions: W x D x H, 184 x 457 x 30 mm
- Metal/plastic: alu/dark-grey
- Weight: 420 g
- Packing dimensions: W x D x H, 455 x 155 x 80 mm

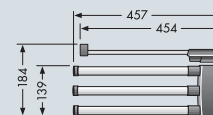
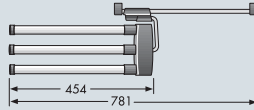

4 007126 313300



Übrigens, wussten Sie, ...

dass die Marke Hailo in Deutschland einen Bekanntheitsgrad von etwa 53% besitzt?

By the way, did you know...

that the Hailo brand enjoys a recognition factor of approx. 53% in Germany?

Hailo Deposito light.

Hailo Deposito light.



Für Schränke ab 450 mm Breite mit Frontauszug For cabinets from 450 mm width front-mount-door

Hailo Deposito light



16 mm Korpusstärke
16 mm side-walls

450 mm Breite

- Einfache Seitenwandmontage
- Hochwertiges Kunststoffmodul weiß
- (16 oder 19mm Korpusstärke)
- Praktische Ablage
- Attraktive Verblendung / sichtbar
- Verpackungsmaße: B x T x H, 195 x 105 x 420 mm
- Gewicht 350 g
- Gewicht mit Verpackung 4,5 kg

19 mm Korpusstärke
19 mm side-walls

Hailo Deposito light



16 mm Korpusstärke
16 mm side-walls

500 mm Breite

- Einfache Seitenwandmontage
- Hochwertiges Kunststoffmodul weiß
- (16 oder 19mm Korpusstärke)
- Praktische Ablage
- Attraktive Verblendung / sichtbar
- Verpackungsmaße: B x T x H, 195 x 105 x 470 mm
- Gewicht 380 g
- Gewicht mit Verpackung 4,8 kg

19 mm Korpusstärke
19 mm side-walls

Hailo Deposito light



16 mm Korpusstärke
16 mm side-walls

600 mm Breite

- Einfache Seitenwandmontage
- Hochwertiges Kunststoffmodul weiß
- (16 oder 19mm Korpusstärke)
- Praktische Ablage
- Attraktive Verblendung / sichtbar
- Verpackungsmaße: B x T x H, 195 x 105 x 570 mm
- Gewicht 430 g
- Gewicht mit Verpackung 5,3 kg

19 mm Korpusstärke
19 mm side-walls

Passend für Schränke
Suitable for cabinets **45 cm**

450 mm width

- Easy Installation onto side-walls
- High Quality Plastic components, white
- 16 mm thru 19 mm side-walls.
- Practical Storage Area
- Handsome Lining for sink-units
- Packing dimensions: W x D x H, 195 x 105 x 420 mm
- Weight 350 g
- Weight incl. packing 4,5 kg

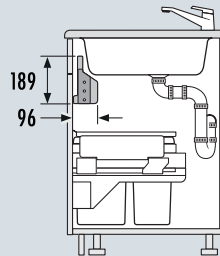

Passend für Schränke
Suitable for cabinets **50 cm**

500 mm width

- Easy Installation onto side-walls
- High Quality Plastic components, white
- 16 mm thru 19 mm side-walls.
- Practical Storage Area
- Handsome Lining for sink-units
- Packing dimensions: W x D x H, 195 x 105 x 470 mm
- Weight 380 g
- Weight incl. packing 4,8 kg

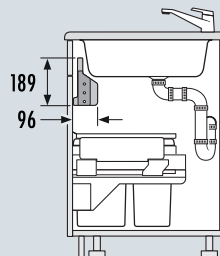

Passend für Schränke
Suitable for cabinets **60 cm**

600 mm width

- Easy Installation onto side-walls
- High Quality Plastic components, white
- 16 mm thru 19 mm side-walls.
- Practical Storage Area
- Handsome Lining for sink-units
- Packing dimensions: W x D x H, 195 x 105 x 570 mm
- Weight 430 g
- Weight incl. packing 5,3 kg

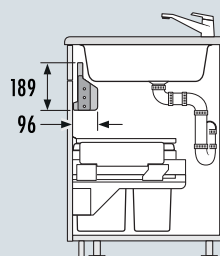

Für Drehtür- und Frontauszugsschränke ab 600 mm Breite

For cabinets with hinged doors as well as with front-mounted doors from 600 mm width

Hailo Deposito Kippsystem



- Kippsystem, Stauraumvolumen Gesaminhalt 9,3 l
- **Passend für Drehtür- und Frontauszugsschränke (16 und 19 mm Korpusstärke).**
- **Montageart: Seitenwandmontage**
- Stahlblech silberfarben / Aluminium eloxiert / Kunststoffteile dunkelgrau / Anti-Rutsch-Matte silberfarben
- Produkt-Maße: B x T x H, 562-568 x 183 x 188 mm
- Verpackungsmaße: B x T x H, 550 x 225 x 220 mm
- Gewicht mit Verpackung 2,4 kg

Das Deposito Kippsystem ist zum Schutz der Utensilien mit einer geriffelten Anti-Rutsch-Matte ausgelegt.

Deposito Tilting System

Passend für Schränke
Suitable for cabinets

60 cm

- Tilt-down Box, Total capacity 9,3l
- **Suitable for cabinets with hinged doors as well as with front-mounted doors (side walls of 16 and 19 mm).**
- Type of installation: Sidewall mounting
- Sheet steel silver-coloured / Aluminium anodized / Plastic parts dark-grey / Anti-slip-mat silver-coloured
- Product dimensions: W x D x H, 562-568 x 183 x 188 mm
- Packing dimensions: W x D x H, 550 x 225 x 220 mm
- Weight incl. packing 2,4 kg

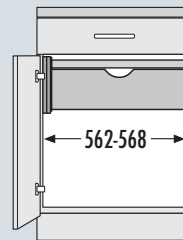
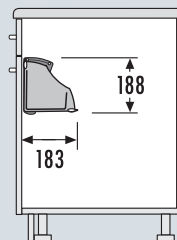

The Deposito Tilting System comes with anti-slip-mat.



Übrigens, wussten Sie, ...

dass Hailo bereits in der
Gründungszeit 1947 Abfallsammler
produzierte?

By the way, did you know...

that Hailo has been producing
waste bins right from the outset,
early 1947?

Hailo Deposito.

Hailo Deposito.



Deposito

3981601

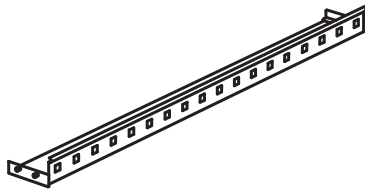

Regalsystem

Flachdunstregal, für 16 mm und 19 mm Seitenwandstärke

- Schrankbreite: 600 mm
- Seitenwände: 16 mm + 19 mm
- Einbaumaße T x H: 72 x 42,5 mm
- Verpackungsmaße: B x T x H, 565 x 120 x 66 mm
- Montgeart: Seitenwandmontage
- Lochraster: 32 mm
- Kunststoffteile: graphitgrau/
Metallteile: silber
- **Verpackungseinheit: 10**

Deposito

3981901

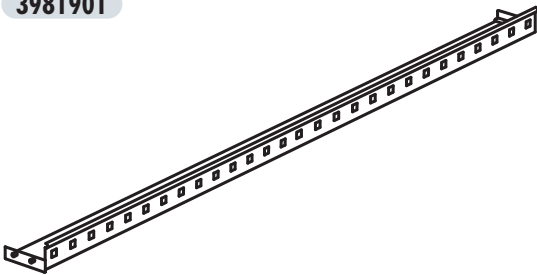

Regalsystem

Flachdunstregal, für 16 mm und 19 mm Seitenwandstärke

- Schrankbreite: 900 mm
- Seitenwände: 16 mm + 19 mm
- Einbaumaße T x H: 72 x 42,5 mm
- Verpackungsmaße: B x T x H, 865 x 120 x 66 mm
- Montgeart: Seitenwandmontage
- Lochraster: 32 mm
- Kunststoffteile: graphitgrau/
Metallteile: silber
- **Verpackungseinheit: 10**

Rack System

Shelf for extractor fan units with 16 and 19 mm side wall thickness

- Cabinet width: 600 mm
- Side wall thickness: 16 mm + 19 mm
- Built-in dimensions T x H: 72 x 42,5 mm
- Packing dimensions: W x D x H, 565 x 120 x 66 mm
- Kind of installation: side wall mounting
- Distance of holes: 32 mm
- Plasticparts: graphite grey/
Metal parts: silver
- **Packing unit: 10 each per carton**



Rack System

Shelf for extractor fan units with 16 and 19 mm side wall thickness

- Cabinet width: 900 mm
- Side wall thickness: 16 mm + 19 mm
- Built-in dimensions T x H: 72 x 42,5 mm
- Packing dimensions: W x D x H, 865 x 120 x 66 mm
- Kind of installation: side wall mounting
- Distance of holes: 32 mm
- Plasticparts: graphite grey/
Metal parts: silver
- **Packing unit: 10 each per carton**





Übrigens, wussten Sie, ...

dass Hailo Einbautechnik Produkte mit über 100.000 Auszugszyklen getestet werden, bevor sie auf den Markt kommen?

By the way, did you know...

that Hailo Built-In Technology Products are tested on more than 100,000 pull-out cycles before they reach the market?

Hailo Vario.
Hailo Vario.



Swing



Für Schränke ab 400 mm Breite mit Drehtür For hinged door cabinets from 400 mm width

Vario

3901001

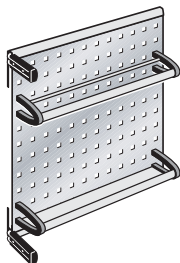

- Das Ordnungssystem für Unterschränke mit Frontauszug
- Montageart: Seitenwandmontage
- Metallteile silberfarben, Alu eloxiert/
Kunststoffteile dunkelgrau
- Einbau-Maße: ab 200 mm Schrankbreite
- Produkt-Maße: B x T x H, 108 x 492 x 481 mm
- Verpackungsmaße: B x T x H, 505 x 120 x 495 mm
- Gewicht mit Verpackung 5,0 kg

Vario

3905001

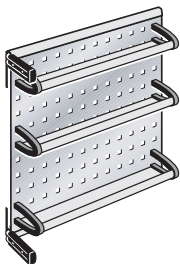

- Das Ordnungssystem für Unterschränke mit Frontauszug
- Montageart: Seitenwandmontage
- Metallteile silberfarben, Alu eloxiert/
Kunststoffteile dunkelgrau
- Einbau-Maße: ab 200 mm Schrankbreite
- Produkt-Maße: B x T x H, 108 x 492 x 481 mm
- Verpackungsmaße: B x T x H, 505 x 120 x 495 mm
- Gewicht mit Verpackung 5,2 kg



Passend für Schränke
Suitable for cabinets

30 40 45 50 60 cm

- The Organizer System for cabinets with front-mounted door
- Type of installation: sidewall
- Metal parts silver-coloured, Aluminium anodized/
Plastic parts dark-grey
- Built-in dimensions: from 200 mm cabinet width
- Product dimensions: W x D x H, 108 x 492 x 481 mm
- Packing dimensions: W x D x H, 505 x 120 x 495 mm
- Weight incl. packing 5,0 kg



Passend für Schränke
Suitable for cabinets

30 40 45 50 60 cm

- The Organizer System for cabinets with front-mounted door
- Type of installation: sidewall
- Metal parts silver-coloured, Aluminium anodized/
Plastic parts dark-grey
- Built-in dimensions: from 200 mm cabinet width
- Product dimensions: W x D x H, 108 x 492 x 481 mm
- Packing dimensions: W x D x H, 505 x 120 x 495 mm
- Weight incl. packing 5,2 kg



Swing



Für Schränke ab 200 mm Breite mit Drehtür
For hinged door cabinets from 200 mm width

Vario

3920001



Einzelauszug

- Der Einzelauszug nutzt sogar den Raum über den Abfalltrennsystemen.
- Metallteile silberfarben, Alu eloxiert/
Kunststoffteile dunkelgrau
- Einbau-Maße: ab 200 mm Schrankbreite
- Produkt-Maße: B x T x H, 155 x 480 x 173 mm
- Montageart: Rechts-/Linksmontage
- Verpackungsmaße: B x T x H, 498 x 188 x 165 mm
- Gewicht mit Verpackung 3,1 kg

Vario

3902001



- Das Ordnungssystem Combi Vario nutzt die kleinste Nische als Stauraum.
- Seitenwandmontage, Rechts-/Linksmontage
- Metallteile silberfarben, Alu eloxiert/
Kunststoffteile dunkelgrau
- Einbau-Maße: ab 200 mm Schrankbreite
- Produkt-Maße: B x T x H, 158 x 483 x 481 mm
- Verpackungsmaße: B x T x H, 505 x 170 x 495 mm
- Gewicht mit Verpackung 5,8 kg

Vario

3903001



- Seitenwandmontage, Rechts-/Linksmontage
- Metallteile silberfarben, Alu eloxiert/
Kunststoffteile dunkelgrau
- Einbau-Maße: ab 200 mm Schrankbreite
- Produkt-Maße: B x T x H, 158 x 483 x 481 mm
- Verpackungsmaße: B x T x H, 505 x 170 x 495 mm
- Gewicht mit Verpackung 6,45 kg

Vario

3909001



- Seitenwandmontage, Rechts-/Linksmontage
- Metallteile silberfarben, Alu eloxiert/
Kunststoffteile dunkelgrau
- Einbau-Maße: ab 200 mm Schrankbreite
- Produkt-Maße: B x T x H, 158 x 483 x 481 mm
- Verpackungsmaße: B x T x H, 505 x 170 x 495 mm
- Gewicht mit Verpackung 5,5 kg

Single pull-out Tray

Passend für Schränke
Suitable for cabinets

30 40 45 50 60 cm

- **The single pull-out Vario-Tray uses even the space above the waste separation system.**
- Metal parts silver-coloured, Aluminium anodized, Plastic parts dark-grey
- Built-in dimensions: from 200 mm Cabinet width
- Product dimensions: W x D x H, 155 x 480 x 173 mm
- Type of installation: Right-/Left-hand sidewall
- Packing dimensions: W x D x H, 160 x 480 x 180 mm
- Weight incl. packing 3,1 kg



- **The Vario-Organizer System uses even the smallest space for storage.**
- Type of installation: Right-/Left-hand sidewall
- Metal parts silver-coloured, Aluminium anodized/ Plastic parts dark-grey
- Built-in dimensions: from 200 mm Cabinet width
- Product dimensions: W x D x H, 158 x 483 x 481 mm
- Packing dimensions: W x D x H, 505 x 170 x 495 mm
- Weight incl. packing 5,8 kg



- Type of installation: Right-/Left-hand sidewall
- Metal parts silver-coloured, Aluminium anodized/ Plastic parts dark-grey
- Built-in dimensions: from 200 mm Cabinet width
- Product dimensions: W x D x H, 158 x 483 x 481 mm
- Packing dimensions: W x D x H, 505 x 170 x 495 mm
- Weight incl. packing 6,45 kg



- Type of installation: Right-/Left-hand sidewall
- Metal parts silver-coloured, Aluminium anodized/ Plastic parts dark-grey
- Built-in dimensions: from 200 mm Cabinet width
- Product dimensions: W x D x H, 158 x 483 x 481 mm
- Packing dimensions: W x D x H, 505 x 170 x 495 mm
- Weight incl. packing 5,5 kg



Übrigens, wussten Sie, ...

dass Hailo Produkte bereits viele Auszeichnungen erhalten haben?

By the way, did you know...

that Hailo products have already won many awards?



reddot award



Hailo Carry.
Hailo Carry.



Einsatz für Schränke ab 400 mm Breite For cabinets with pull-out shelf from 400 mm width

Hailo Carry



3950001



Hailo Carry

Der Hailo Carry ist ausgestattet mit zwei Tragekörben, aufsteckbar auf Auszugssystem mit Selbsteinzug und Dämpfung – schließt sanft und leise.

Durch einfaches herausziehen der mobilen Utensilienkörbe können z.B. Putzmittel zu ihrem Einsatzort getragen werden.

- Schiene gedämpft, abgedeckt
- Farbe hellgrau
- Einbau-Maße: B x T x H, 245 x 459 x 395 mm
- Verpackungsmaße: B x T x H, 504 x 260 x 420 mm
- Gewicht mit Verpackung 6 kg

Hailo Carry

Der Begleiter im Spülenunterschrank. kombinierbar mit unterschiedlichen Hailo-Produkten, z. B. mit unseren bodenmontierten Mülltrennsystemen.

Hailo Carry



3951001



Hailo Carrying Bag

Robuste Wertstofftasche zum Sammeln von Wertstoffen wie Glas, Papier, Dosen und Verpackungen.

Einfach den Beutel aushängen und den Wertstoff im Sack zum Sammelbehälter tragen – ohne Umfüllen.

Gewebesack leicht entnehmbar und abwaschbar.

- Schiene gedämpft, abgedeckt
- Farbe hellgrau
- Einbau-Maße: B x T x H, 233 x 459 x 410 mm
- Verpackungsmaße: B x T x H, 504 x 260 x 420 mm
- Gewicht mit Verpackung 5 kg



Designpreis
Deutschland
2011
NOMINIERT

Passend für Schränke
Suitable for cabinets

40 45 50 60 cm



The Hailo Carry comes with carrying Baskets easily removable, transportable, and attachable.

Pullout tray with low-noise, full-extension, self-closing & -dampening slides.

The transportable, utensil Baskets for any cleansers, agents, etc., may be carried to the spot.

- Damped and covered slides
- colour light grey
- Built-In dimensions: W x D x H, 245 x 459 x 395 mm
- Packing dimensions: W x D x H, 504 x 260 x 420 mm
- Weight incl. packing 6 kg

Hailo Carry

The helper in your sink unit, may be combined with various Hailo products, such as bottom-mount recycling systems.

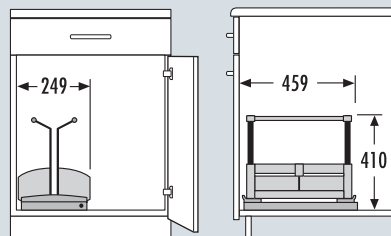

Large volume fibre-cloth bag for collection of recyclable bottles, paper, cardboard, etc.

Easy removal for carrying to the local recyclables containers, without repacking.

Useful complement to our bottom-mount recycling pullout systems.

- Damped and covered slides
- colour light grey
- Nylon bags easy to remove and to clean, resp. to wash.
- Built-In dimensions: W x D x H, 233 x 459 x 410 mm
- Packing dimensions: W x D x H, 504 x 260 x 420 mm
- Weight incl. packing 5 kg

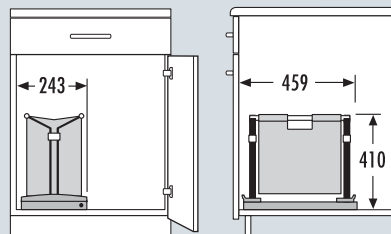

Funktionssysteme

Functional systems



Libero



Seite/ Page 197 - 199

Libero 2.0



Seite/ Page 200 - 201

Kick and go



Seite/ Page 202 - 205

Ausziehtische
Pull-out tables



Seite/ Page 207 - 209

Stepfix



Seite/ Page 211 - 215



Übrigens, wussten Sie, ...

dass der Hailo Libero das einzige elektronische Öffnungssystem ist, das individuell bei Auszügen aller Art eingesetzt werden kann?

By the way, did you know...

that the Hailo Libero is the one and only electronic hands-free opening device that may, universally, be used for any type of pull-out?





HAILO LIBERO HANDSFREEOPEN

AUSZÜGE ÖFFNEN – AUTOMATISCH UND KOMFORTABEL
Drawers open automatically and easily

Hailo Libero – Hands Free Opener

Die Öffnungsunterstützung von Hailo für ein automatisches, komfortables Öffnen aller Abfalltrennsysteme mit Frontanbindung und aller Auszugssysteme.

Hailo Libero – Hands Free Opener

Hailo's electronic front-mount-door and drawer-opener Libero offers an automatic, comfortable hands-free opening of all waste-recycling-systems with attached door-panel, and of any common, also damped, drawer-mounted systems.

Hailo Libero

Hailo Libero – Hands Free Opener

Für den meist genutzten Auszug in der Küche, dem Spülen- bzw. Müllschrank, glänzt Hailo – Libero mit folgenden Vorteilen:

- Einfache Bedienung durch Fußbetätigung mittels Sensor im Sockelbereich
- Kein unbeabsichtigtes Öffnen beim Anlehnen an die Front
- Integrierte Auffindbeleuchtung (LED)
- Ein System für alle Auszugsarten, ob stehende oder hängende Abfalltrennsysteme
- Einstellbare Auswurfkraft (5-fach justierbar)
- Sanftes Schließen des Abfalltrennsystems mit den gewohnten Lauf- und Dämpfungseigenschaften der jeweiligen Schienen
- Einfacher Einbau ohne Sonderzubehör
- Platzsparende, patentierte Installation im Sockelraum, hinterer Bereich des Schrankes bleibt frei
- Plug-and Play: Netzspannung: 230 V AC +/- 10%
 Netzfrequenz: 50 Hz bzw. 60 Hz *
- Produktmaße: 216 x 176 x 42 mm
- Verpackungsmaße: 240 x 220 x 57 mm

Hailo Libero

3697101



Hailo Libero

Die neue Öffnungsunterstützung Libero ist konzipiert für die Anwendung im Unterschrank mit seitenwand-montiertem Frontauszugssystem.

Der platzsparende Einbau direkt im Schrankboden sorgt für eine störungsfreie Auszugsfunktion, ohne Beeinträchtigung im Bereich des Syphons, im Spülenunterschrank.

Kann in Verbindung mit Metalltüren, gerahmten Metalltüren und Metall-Sockeln zu Funktionsstörungen führen.

Automatische Türöffner für Auszugssysteme

Automatic Door-Openers/ Toe-Kicks recycling-systems



Hailo Libero – Hands Free Opener

For the most frequently opened pull-out in the kitchen, the waste-recycling-system, the new Hailo Libero offers the following advantages:

- Easy operation by foot, thanks to a sensor in the plinth-area
- Integrated identification lighting (LED)
- Not any unintended opening, e.g. by touching of the door-front, or by walking by
- One opener system for all types of pull-outs, or dampened drawers for self-containing systems, for hang-thru bins, for bins standing on the drawer-bottom
- Adjustable push-out forces (5 different settings for any type of slides)
- Soft closing of the recycling-systems, with the known features of used slides
- Easiest installation, within minutes, without any special tooling or accessories
- Space-saving patented installation in the bottom-panel of the cabinet, not any interference with plumbing lines in the rear section
- Plug-and-Play, comes with 230 V (+/-10%), 50-60 Hz, European 2-pin power-plug *
- Built-In dimensions: W x D x H, 216 x 176 x 42 mm
- Packing dimensions: W x D x H, 240 x 220 x 57 mm



HFO

The new hands-free opener Libero is designed for base cabinets with side-mounted recycling-systems with attached front-panel, or for drawer-cabinets with any common European brand drawers (designed for lower drawer / first drawer from bottom). The easy, space-saving installation at the forward edge of the cabinet bottom ensures a trouble-free pushing out, without wasting any limited space in the rear-section of the sink-cabinet.

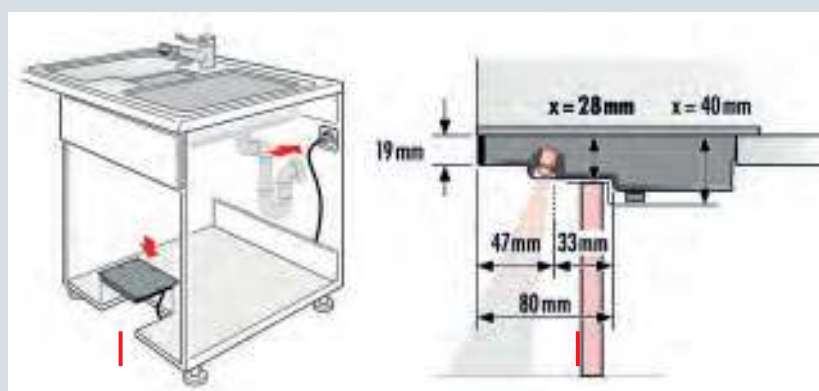

If installed behind a door-panel with a metal frame, or behind a metal cabinet-front, or above a metal plinth, malfunctions may occur.



Hailo Libero 2.0

Funktionsbeschreibung

Einfache Bedienung durch Fußbetätigung mittels Sensor im Sockelbereich. Die integrierte LED Leuchte dient zur Auffindung des Sensors.

Hailo Libero 2.0

- Für Unterschränke von 300 mm bis 1200 mm Breite
- Montage im vorderen Bereich des Schrankbodens
- Kann einfach nachgerüstet werden
- Niedervoltgerät (5V), mit Micro-USB Buchse
- Stromversorgung über herkömmliche Steckdosen 110 - 230 V, mit 2 m Kabel Micro-USB/ USB Stecker inkl. Netzteil und internationalen Adapter
- Einfache Bedienung durch Fußsensor oder Fernbedienung (optional erhältlich)
- Integrierte Auffindbeleuchtung, dimmbar, abschaltbar
- Auswurfstärke einstellbar
- Kein unbeabsichtigtes Öffnen
- Intelligente Steuerung, erkennt Hindernisse dank Rutschkupplung
- Spritzwassergeschützt nach IP 21 Zertifizierung
- Mit europäischen, britischen und nordamerikanischen Zertifizierungen
- Einstellungen und Konfigurationen über Hailo Smartphone App für Android und iOS
- Eigenes WLAN, somit sicher gegen Fremdzugriffe durch das WWW
- Entwicklung und Herstellung in Deutschland
- Abmessungen: 157 mm x 300 mm x 33 mm (BxTxH)

NEW Hands Free Opener

3697201



ANDROID



IOS

Hailo Libero 2.0

3697211



Fernbedienung, optionales Zubehör

Libero 2.0 Fernbedienung, optionales Zubehör

- Für US-Schränke empfohlen
- Einfache Verbindung über Pairing Funktion zwischen Öffnungseinheit und Fernbedienung
- Reichweite 10 m (11 yard)
- Deep-sleep Technologie verlängert Batterielebensdauer
- Spannungsversorgung: 2 x Micro AAA Batterien (im Lieferumfang enthalten)
- Abmessungen: 89 x 38 x 17 mm (BxTxH)

Automatische Öffnungsunterstützung für alle Auszugssysteme

One opener system for all types of pull-outs, and for side-mounted, self-containing systems



Hailo Libero 2.0

Functional description

Easy operation by foot, thanks to a sensor in the plinth-area. The integrated LED light indicates the sensor position.

Hailo Libero 2.0

- For base cabinets from 300 mm to 1200 mm (12 in. to 48 in.) widths
- Mounts in forward section of bottom-panel
- Can also easily be retrofitted
- Low Voltage device, 5 V input, comes with Micro-USB socket
- Power supply by mobile-phone charger/ transformer for 110 V thru 230 V outlets, with 2m Micro-USB/ USB cable and international adapters
- Easy operation by foot sensor (or by optional remote control)
- Integrated location lighting, may be dimmed and switched off
- Push-out force adjustable
- No unintended opening
- Intelligent controls, identifies obstacles thanks to friction clutch
- Splash-water proof according to IP 21 certification
- Comes with European, British, and North American Certifications
- Settings and Adjustments via Hailo Smart-Phone App for Android and IOS
- Independent WLAN, secured against acces from www.
- Developed and Made in Germany
- Dimensions: 157 mm x 300 mm x 33 mm (WxDxH) 6-1/8 in. x 11-3/4 in. x 1-1/4 in.

NEW

Hands Free Opener

HAILO LIBERO 2.0

Die Weiterentwicklung des elektronischen Türöffners Hailo Libero – der Hailo Libero 2.0

The modified and improved, further development of the unique Hailo HFO – Libero, the new Hailo Libero 2.0, electronic sensor opener, also designed for North America.



Remote Control, optional extra accessory

Libero 2.0 Remote Control, optional extra accessory

- Recommended for US face-frame-cabinets
- Pairing function simplifies connection between opener unit and remote control
- Range 10 m (11 yards)
- Deep-sleep technology extends battery life
- Power supply: 2 x Micro AAA batteries (included in scope of supply)
- Dimensions: 89 x 38 x 17 mm (BxTxH)



Automatische Türöffner für Auszugssysteme

Automatic Door-Openers/ Toe-Kicks recycling-systems

Kick and go

Fußhebel

3691301



Fußhebel "Kick and go" für Frontauszüge und untere Schubkästen

Kick and go

Fußhebel

3691401



Fußhebel "Kick and go" für Cargo Basic 3609

Kick and go

Fußhebel

3691501



Fußhebel "Kick and go" für Euro Cargo mit ungedämpften Schienen

Foot Pedal

Foot Pedal "Kick and go" for Front mounted door and lower drawer

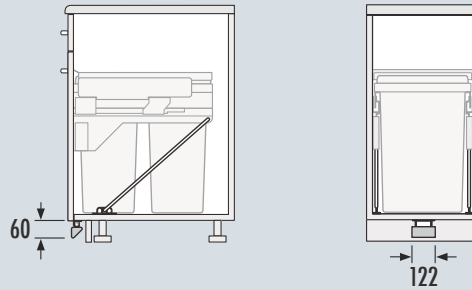

Foot Pedal

Foot Pedal "Kick and go" for Cargo Basic series 3609-xxx

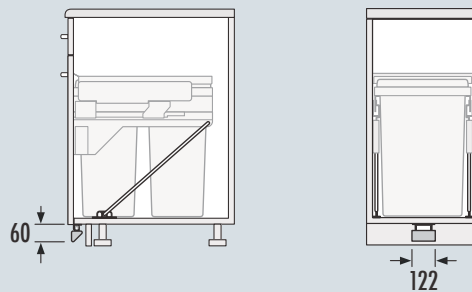

Foot Pedal

Foot Pedal "Kick and go" for non dampened Euro Cargos, only

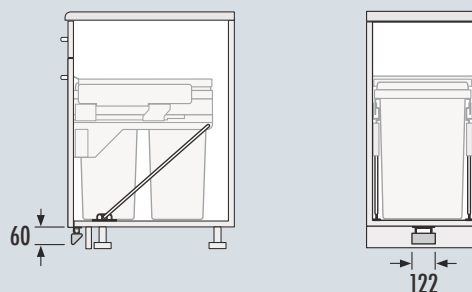

Automatische Türöffner für Auszugssysteme

Automatic Door-Openers/ Toe-Kicks recycling-systems

Kick and go

Türöffner

3697001

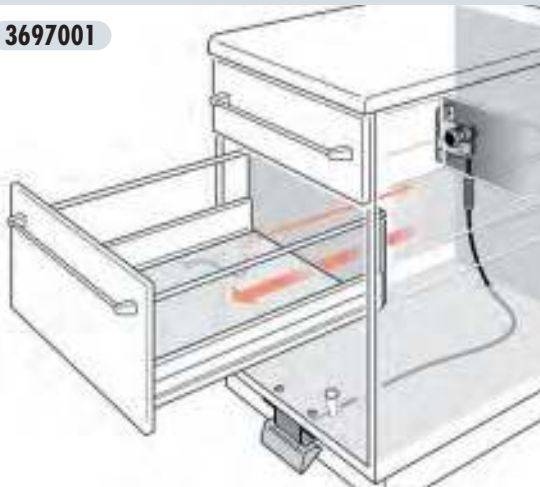

Türöffner für oben liegende Schubladen

Für Frontauszüge ab 300 mm
inklusive Magnetteil, Bowdenzug, Metallmagnethalteplatte
und Gummiexpander.

B x H: 122 x 60 mm

Kick and go

Türöffner

3692021

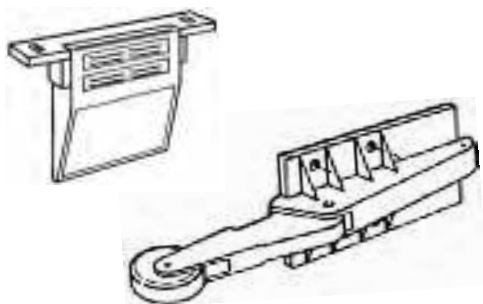

Türöffner für Drehtüren

Für Drehtüren ab 300 mm
Federdruckelement aus Kunststoff, mit Fußhebel,
Magnetteil, Metallmagnethalteplatte.

Pedal-Opener

Pedal-Opener for upper drawers.

For front-mount-doors from 300 mm -
including magnetic catch, counter-plate,
Bowden-cable and rubber expander-strings.

W x H: 122 x 60 mm



Door-Opener

Door-Opener for hinged doors.

For hinged doors from 300 mm,
with magnetic catch, counter-plate,
and spring-loaded roller arm.



Übrigens, wussten Sie, ...

By the way, did you know...



dass Hailo bereits in den 50er Jahren als erstes Unternehmen einen Einbau-Ausziehtisch für Küchenmöbel auf den Markt brachte?

that Hailo, as the first company, introduced a built-in pull-out table for kitchen base-cabinets in the 1950s?

Auszugsweise Platz.
Pulled out Space.



Auszugsweise Platz. Pulled out Space.

Rapid

Rapid für 500er Breite

3845101



- Modell 3845101
- Dekor Phosphor
- Seitenwände: 16 mm + 19 mm
- Einbau ab Schrankbreite: 500 mm
- Einbau-Maße: B x T x H, 431 x 490 x 120 mm
- Tischplatte/Ausziehfläche: B x L, 421 x 800 mm
- Stufenlos ausziehbar
- Belastbar bis 100 kg
- Gewicht: 10,2 kg
- Verpackungsmaße: B x T x H, 135 x 510 x 470 mm

Rapid

Rapid für 600er Breite

3845091



- Modell 3845091
- Dekor Phosphor
- Seitenwände: 16 mm + 19 mm
- Einbau ab Schrankbreite: 600 mm
- Einbau-Maße: B x T x H, 561 x 490 x 120 mm
- Tischplatte/Ausziehfläche: B x L, 521 x 800 mm
- Stufenlos ausziehbar
- Belastbar bis 100 kg
- Gewicht: 11 kg
- Verpackungsmaße: B x T x H, 135 x 510 x 575 mm

3845601



- Modell 3845601
- Dekor Weiß (RAL 9010)
- Seitenwände: 16 mm + 19 mm
- Einbau ab Schrankbreite: 600 mm
- Einbau-Maße: B x T x H, 561 x 490 x 120 mm
- Tischplatte/Ausziehfläche: B x L, 521 x 800 mm
- Stufenlos ausziehbar
- Belastbar bis 100 kg
- Gewicht: 11 kg
- Verpackungsmaße: B x T x H, 135 x 510 x 575 mm

3845121



- Modell 3845121
- Dekor Edelstahl (RAL 7038)
- Seitenwände: 16 mm + 19 mm
- Einbau ab Schrankbreite: 600 mm
- Einbau-Maße: B x T x H, 561 x 490 x 120 mm
- Tischplatte/Ausziehfläche: B x L, 521 x 800 mm
- Stufenlos ausziehbar
- Belastbar bis 100 kg
- Gewicht: 11 kg
- Verpackungsmaße: B x T x H, 135 x 510 x 575 mm

Rapid for width 500 mm

- Type 3845101
- Dekor „Phosphor“
- Side wall thickness: 16 mm + 19 mm
- Min. cabinet width reqd.: 500 mm
- Built-in dimensions: B x T x H, 431 x 490 x 120 mm
- Table extended: W x L, 421 x 800 mm
- Continuously extendible
- Load bearing capacity 100 kg
- Weight: 10,2 kg
- Packed dimensions: W x D x H, 135 x 510 x 470 mm



Rapid for width 600 mm

- Type 3845091
- Dekor „Phosphor“
- Side wall thickness: 16 mm + 19 mm
- Min. cabinet width reqd.: 600 mm
- Built-in dimensions: B x T x H, 561 x 490 x 120 mm
- Table extended: W x L, 521 x 800 mm
- Continuously extendible
- Load bearing capacity 100 kg
- Weight: 11 kg
- Packed dimensions: W x D x H, 135 x 510 x 575 mm



- Type 3845601
- Dekor „white“ (RAL 9010)
- Side wall thickness: 16 mm + 19 mm
- Min. cabinet width reqd.: 600 mm
- Built-in dimensions: B x T x H, 561 x 490 x 120 mm
- Table extended: W x L, 521 x 800 mm
- Continuously extendible
- Load bearing capacity 100 kg
- Weight: 11 kg
- Packed dimensions: W x D x H, 135 x 510 x 575 mm

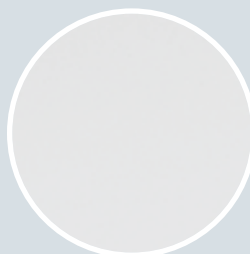

- Type 3845121
- Dekor „steel/alubushed“ (RAL 7038)
- Side wall thickness: 16 mm + 19 mm
- Min. cabinet width reqd.: 600 mm
- Built-in dimensions: B x T x H, 561 x 490 x 120 mm
- Table extended: W x L, 521 x 800 mm
- Continuously extendible
- Load bearing capacity 100 kg
- Weight: 11 kg
- Packed dimensions: W x D x H, 135 x 510 x 575 mm

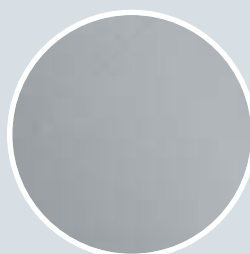



Übrigens, wussten Sie, ...

dass Hailo im Verzeichnis „Marken des Jahrhunderts“ neben anderen 300 Premiummarken vertreten ist?

By the way, did you know...

that Hailo is amongst 300 premium brands listed in the “Brands of the Century” guide?

Sicherer Auftritt.

Save appearance.



2. Generation

Stepfix®

4400101



- Einbau-Maße: B x T x H, 41,5 x 46 x 8,2 cm
- Produkt-Maße: B x T x H, 41,3 x 41,9 x 38,6 cm
- Metall-Teile: Aluminium eloxiert/Stahl glanzverzinkt
- Kunststoff-Teile: dunkelgrau
- 2 Stufen B x T: 33 x 20 cm
- Tritthöhe: 19 cm/38 cm
- Gewicht: 3,2 kg/3,7 kg Brutto
- Verpackungsmaße: B x T x H, 43 x 9,5 x 45 cm

Stepfix®

4400991



Sockelblendenhalter für 4400101

- Glanzverzinkt
- Verpackungsmaße: B x T x H, 19 x 43 x 10 cm
- Gewicht mit Verpackung: 1,3 kg
- **Verpackungseinheit: 10**

Stepfix®

4493001



Wandhalter für alle Stepfix Modelle

- Metall-Teile: Weiß
- Produkt-Maße: B x T x H, 144 x 37 x 30 cm
- Verpackungsmaße: B x T x H, 197 x 150 x 97 cm
- Gewicht: 1,6 kg
- **Verpackungseinheit: 10**

Stepfix®

4412101



1. Generation

- Einbau-Maße: B x T x H, 40,5 x 46,4 x 9,5 cm
- Produkt-Maße: B x T x H, 40,5 x 39 x 38,2 cm
- Metall-Teile: Silber
- Kunststoff-Teile: Schwarz
- 2 Stufen B x T: 30 x 20 cm
- Tritthöhe: 35,5 cm
- Gewicht mit Verpackung: 3,4 kg
- Verpackungsmaße: B x T x H, 42,0 x 10 x 47,0 cm

- Built-in dimensions: W x D x H, 41,5 x 46 x 8,2 cm
- Product dimensions: W x D x H, 41,3 x 41,9 x 38,6 cm
- Metal parts: Aluminium anodized/Steel galvanized
- Plastic parts: graphitegrey
- 2 treads W x D: 33 x 20 cm
- Stepping height: 19 cm/38 cm
- Weight: 3,2 kg/3,7 kg Brutto
- Packing dimensions: W x D x H, 43 x 9,5 x 45 cm



Plinth bracket for 4400101

- Glanzverzinkt
- Packing dimensions: 19 x 43 x 10 cm
- Weight incl. packing 1,3 kg
- **Packing unit 10**



Universal bracket for all Stefix models

- Metal parts: white
- Product dimensions: W x D x H, 144 x 37 x 30 cm
- Packing dimensions: W x D x H, 197 x 150 x 97 cm
- Weight: 1,6 kg
- **Packing unit 10**



- Built-in dimensions: W x D x H, 40,5 x 46,4 x 9,5 cm
- Product dimensions: W x D x H, 40,5 x 39 x 38,2 cm
- Metal parts: silvercoloured
- Plastic parts: black
- 2 treads W x D: 30 x 20 cm
- Stepping height: 35,5 cm
- Weight incl. packing: 3,4 kg
- Packing dimensions: W x D x H, 42,0 x 10 x 47,0 cm



Stepfix®

4412801

1. Generation



- Einbau-Maße: B x T x H, 40,5 x 46,4 x 9,5 cm
- Produkt-Maße: B x T x H, 40,5 x 39 x 38,2 cm
- Metall-Teile: Weiß
- Kunststoff-Teile: Grau
- 2 Stufen B x T: 30 x 20 cm
- Tritthöhe: 35,5 cm
- Gewicht mit Verpackung: 3,4 kg
- Verpackungsmaße: B x T x H, 42,0 x 10 x 47,0 cm

Stepfix®

4490001

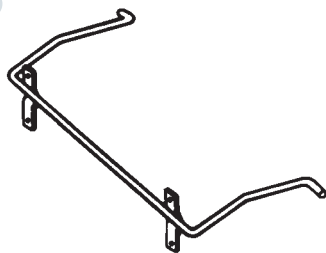

Sockelblendenhalter

- Einbau-Maße: B x T x H, 39,5 x 14 x 4,5 cm
- Produkt-Maße: B x T x H, 2 x 16,5 x 50 cm
- Metall-Teile: verzinkt
- Gewicht mit Verpackung: 1,3 kg
- Verpackungsmaße: B x T x H, 44,5 x 19 x 8,5 cm
- **Verpackungseinheit: 10**

Stepfix®

4491101

Silber/silver

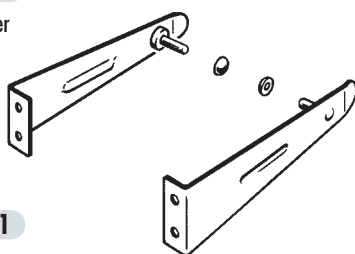

4491901

Weiß/white

Sockelblendenhalter

- Einbau-Maße: B x T x H, 39,5 x 14 x 4,5 cm
- Produkt-Maße: B x T x H, 2 x 16,5 x 50 cm
- Metall-Teile: verzinkt
- Kunststoff-Teile: Silber/Weiß
- Gewicht mit Verpackung: 2,7 kg
- Verpackungsmaße: B x T x H, 22,5 x 19,4 x 7,8 cm
- **Verpackungseinheit: 10**

- Built-in dimensions: W x D x H, 40,5 x 46,4 x 9,5 cm
- Product dimensions: W x D x H, 40,5 x 39 x 38,2 cm
- Metal parts: white
- Plastic parts: grey
- 2 treads W x D: 30 x 20 cm
- Stepping height: 35,5 cm
- Weight incl. packing: 3,4 kg
- Packing dimensions: W x D x H, 42,0 x 10 x 47,0 cm



Plinth bracket

- Built-in dimensions: W x D x H, 39,5 x 14 x 4,5 cm
- Product dimensions: W x D x H, 2 x 16,5 x 50 cm
- Metal parts: galvanized wire
- Weight incl. packing: 1,3 kg
- Packing dimensions: W x D x H, 44,5 x 19 x 8,5 cm
- **Packing unit: 10**



Plinth bracket

- Built-in dimensions: W x D x H, 39,5 x 14 x 4,5 cm
- Product dimensions: W x D x H, 2 x 16,5 x 50 cm
- Metal parts: galvanized wire
- Plastic parts: silver/white
- Weight incl. packing: 2,7 kg
- Packing dimensions: W x D x H, 22,5 x 19,4 x 7,8 cm
- **Packing unit: 10**



Wäschepflege / Hauswirtschaftsraum

Laundry care / Utility Room



Laundry Area



Seite/ Page 219 - 227

Laundry Carrier



Seite/ Page 229 - 233

**Wertstoffdepot
Collector**



Seite/ Page 234 - 235

Bad-Kosmetikeimer



Seite/ Page 237 - 239

Übrigens, wussten Sie, ...



dass Hailo Einbautechnik weltweit
in über 80 Länder exportiert?

By the way, did you know...

that Hailo Built-In Technology
exports to more than 80 countries
around the world?

Hailo Laundry Area.

Hailo Laundry Area.



Swing



Für 60 cm breite Schränke. For 60 cm wide cabinets.

Hailo Laundry Area

Hailo Laundry Area – das Stauraumkonzept für die Wäsche und Zubehör zur Wäschepflege

- Der aufgeräumte Wäscheschrank
- Alles sauber verstaut – und dennoch schnell zur Hand
- 60cm breite Schränke unterschiedlicher Höhen können individuell ausgestattet werden
- Je nach Platz und Ordnungssinn – passende Einbausysteme für jeden Bedarf
- System jederzeit erweiterbar, nachrüstbar und individuell bestückbar
- Modulares, patentiertes System
- Innovative Wandpaneele mit Lochraster werden rechts und links im Schrank verschraubt
- Werkzeuglose Montage der Einbaumodule
- Mit wenigen Handgriffen können Einbauten schnell geändert, nachgerüstet, erweitert werden
- Patentierte Pin-Screw-Technik gewährleistet kinderleichte Montage. Außerdem können durch Drehen des Handrades die Distanzen bei Türscharnieren entsprechend überbrückt werden – egal ob rechts oder links angeschlagen.
- 6 verschiedene Einbaumodule, die individuell nach Bedarf kombiniert werden können
- Robuste, alltagstaugliche Konstruktion und langlebige Materialien
- Ausgezeichnetes, zeitloses Design – Hohe Materialqualität
- Made in Germany – Original Hailo Qualität



Hailo Laundry-Area – the storage space concept for laundry and laundry-care accessories

- The tidy laundry cupboard
- Everything neatly stored away – and yet always at hand
- 60 cm wide cupboards of varying heights can be fitted individually
- Built-in systems suitable for every need, depending on space and sense of order
- System can be expanded, modified, retrofitted and individually fitted at any time
- Modular, patented system
- Innovative metal wall panels with pre-drilled holes, screwed into place on the right and left side of the base-cabinet or closet
- No need for tools to install the modules
- Modules can be quickly changed, retrofitted and extended in a few easy steps
- Patented pin-screw system ensures fast and easy installation. What's more, the clearance needed for door-hinges is easily adjusted by turning the knurled nuts to get the modules slightly off center – whether left-hand or right-hand hinged doors.
- Six different modules can be combined in line with individual requirements
- Sturdy construction for everyday use and durable materials
- Outstanding, timeless design – high-end materials
- Made in Germany – original Hailo quality



Das modulare System. Für individuelle Bestückung.



The Modular System. For individual organizing.

Beispielbestückungen / Examples of Configurations



Beispiel: 72 cm hoher Schrank
bestückt mit 1 Wäschekorb, Ablageboden,
Bügeltscheinheit

Example: 72 cm high cupboard
Fitted with 1 laundry basket, rigid metal-shelf,
ironing-board unit

Perfekt passend für 60 cm breite Drehtürschränke – mit allen gängigen Seitenwandstärken –
egal ob mit rechts oder links angeschlagenen Türen

Perfect fit for 60 cm wide tall cupboards, with standard side-wall thicknesses – with right-hand or left-hand hinged door



Beispiel: 140 cm hoher Schrank
bestückt mit 2 Wäschekörben,
Bügeltscheinheit, Ablageboden,
Utensilienbehälter mit Wandhalter

Example: 140 cm high cupboard
Fitted with 2 laundry baskets, ironing-board unit, metal-shelf,
accessories boxes with wall-bracket



Beispiel: 190 cm hoher Schrank
bestückt mit 2 Wäschekörben,
Ablageboden, Deckenpaneele,
Stabilisierungswinkel für Korpus

Example: 190 cm high, tall cupboard
Fitted with 2 laundry baskets, rigid metal-shelf,
system cover (with holes for coat-hangers),
and stabilizer-bar for carcass



Beispiel: 210 cm hoher Schrank
bestückt mit 2 Wäschekörben, Bügeltscheinheit,
Mehrzweck-Schublade, Ablageboden,
Utensilienbehälter mit Wandhalter, Decken-
paneele, Stabilisierungswinkel für Korpus

Example: 210 cm high, tall cupboard
Fitted with 2 laundry baskets, ironing-board
unit, multipurpose metal-drawer, rigid metal-
shelf, accessories boxes with wall-bracket,
system cover, and stabilizer-bar for carcass

Basis des Systems ist die innovative Lochblech-Platte. Links und rechts im Schrank montiert, bietet sie werkzeuglos Befestigungsmöglichkeiten für alle Module.

Durch raffinierte "Pin-Screw Technik" passend für 60er Drehtürschränke mit allen gängigen Seitenwandstärken. Die nötige Distanz bei Scharnieren wird ebenfalls leicht überbrückt – egal ob rechts oder links angeschlagen. Das Lochblech-Chassis braucht nur einmal mit wenigen Schrauben montiert zu werden – alle Auszug-Module passen sich dann exakt parallel ins Lochgefuge ein.

The basis of the system are the innovative pre-drilled metal-panels. Installed on the left and right sidewall of the cupboard, these are used to easily fix all the modules - with no need for any tools. The ingenious "pin-screw system" is suitable for 60 cm wide, tall closets with hinged doors, with any standard sidewall thicknesses. It easily bridges the clearance needed for the hinges – whether those are mounted on the right or on the left side. The pre-drilled metal-panels only need to be installed once – it just takes a few screws and then all the pull-out modules fit into the attachment- holes, exactly parallel.



Wandpaneel klein
17 Löcher

Wall-Panel small
with 17pairs
pre-drilled holes

Wandpaneel groß
28 Löcher

Wall-Panel large
with 28 pairs
pre-drilled holes



Swing



Für 60 cm breite Schränke.
For 60 cm wide cabinets.

Hailo Laundry Area

3271501



2 Utensilienbehälter

2 Utensilienbehälter mit Wandhalter
(zum Einhängen und Herausnehmen)

Benötigte Anzahl der Löcher zur Montage am Wandpaneel 7

- Kunststoffteile blau,
Korrosionsfest beschichtetes Stahlblech, weiß
- Einbau-Maße: B x T x H, 436 x 198 x 241 mm
- Verpackungsmaße: B x T x H, 390 x 220 x 215 mm
- Gewicht mit Verpackung 1,1 kg

Hailo Laundry Area

3271101



Auszug mit Design-Wäschekorb

Auszug mit Design-Wäschekorb für je eine
Waschmaschinenladung (auf Tablarauszug zum Ein- und
Ausfahren sowie zum einfachen Entnehmen)

Benötigte Anzahl der Löcher zur Montage am Wandpaneel 9

- Kunststoffteile blau,
Korrosionsfest beschichtetes Stahlblech, weiß
- Einbau-Maße: B x T x H, 562-578 x 472 x 360 mm
- Verpackungsmaße: B x T x H, 550 x 545 x 395 mm
- Gewicht mit Verpackung 7,7 kg

Hailo Laundry Area

3271201



Mehrzweck-Schublade

Mehrzweck-Schublade für diverse
Utensilien, die zur Wäschepflege nötig sind.

Benötigte Anzahl der Löcher zur Montage am Wandpaneel 5

- Kunststoffteile blau,
Korrosionsfest beschichtetes Stahlblech, weiß
- Einbau-Maße: B x T x H, 562-578 x 468 x 176 mm
- Verpackungsmaße: B x T x H, 550 x 545 x 215 mm
- Gewicht mit Verpackung 7,25 kg

Two Accessories Boxes

Passend für Schränke
Suitable for cabinets **60 cm**

Two Accessories Boxes with wall-bracket hanger
space required for fitting to wall-panel = 7 attachment holes' height

- plastic parts blue,
metal-parts white epoxy-coated sheet-metal
- Built-In dimensions: W x D x H, 436 x 198 x 241 mm
- Packing dimensions: W x D x H, 390 x 220 x 215 mm
- Weight incl. packing 1,1 kg



Metal-Pullout with design Laundry-Basket

Passend für Schränke
Suitable for cabinets **60 cm**

Metal-Pullout with design Laundry-Basket,
for one machine load each (on pull-out shelf for sliding in
and out, easily removable) space required for fitting to wall-
panel = 9 attachment holes' height

- plastic parts blue,
metal-parts white epoxy-coated sheet-metal
- Built-In dimensions: W x D x H, 562-578 x 472 x 360 mm
- Packing dimensions: W x D x H, 550 x 545 x 395 mm
- Weight incl. packing 7,7 kg



Multipurpose Metal-Drawer

Passend für Schränke
Suitable for cabinets **60 cm**

Multipurpose Metal-Drawer,
for essential laundry care items space required
for fitting to wall-panel = 5 attachment holes' height

- plastic parts blue,
metal-parts white epoxy-coated sheet-metal
- Built-In dimensions: W x D x H, 562-578 x 468 x 176 mm
- Packing dimensions: W x D x H, 550 x 545 x 215 mm
- Weight incl. packing 7,25 kg



Swing



Für 60 cm breite Schränke.
For 60 cm wide cabinets.

Hailo Laundry Area

3271301



Ablageboden

Ablageboden fest im Schrank, praktische Ablage für Textilien und sonstiges.
Benötigte Anzahl der Löcher zur Montage am Wandpaneel 3

- Korrosionsfest beschichtetes Stahlblech, weiß
- Einbau-Maße: B x T x H, 562-578 x 466 x 93 mm
- Verpackungsmaße: B x T x H, 550 x 545 x 215 mm
- Gewicht mit Verpackung 5,25 kg

Hailo Laundry Area

3271801



Deckenpaneel

Deckenpaneel als Stabilitätseinheit des Systems, sowie zum Einhängen von Kleiderbügeln.
Ausschließlich für Seitenwände von 16 mm Stärke

- Korrosionsfest beschichtetes Stahlblech, weiß
- Einbau-Maße: B x T x H, 568 x 323 x 50 mm
- Verpackungsmaße: B x T x H, 580 x 335 x 60 mm
- Gewicht mit Verpackung 1,9 kg

Hailo Laundry Area

3271401



Bügeltischeinheit

Bügeltischeinheit mit praktischem, drehbarem Auszieh-Klapp-Bügeltisch,
Benötigte Anzahl der Löcher zur Montage am Wandpaneel 4

- Einbau-Maße: B x T x H, 562-578 x 466 x 153 mm
- Verpackungsmaße: B x T x H, 550 x 545 x 215 mm
- Gewicht mit Verpackung 15,5 kg

Metal-Shelf

Passend für Schränke
Suitable for cabinets

60 cm

Metal-Shelf, fixed in the cupboard,
handy shelf for textiles and other items.
space required for fitting to wall-panel = 3 attachment holes' height

- plastic parts blue, metal-parts white epoxy-coated sheet-metal
- Built-In dimensions: W x D x H, 562-578 x 466 x 93 mm
- Packing dimensions: W x D x H, 550 x 545 x 215 mm
- Weight incl. packing 5,25 kg



System Cover

Passend für Schränke
Suitable for cabinets

60 cm

System Cover, horizontal,
sheet-metal with punched holes for cloth hangers,
for use in closets with 16 mm side-walls;
modified version for 24 in. closets under construction

- metal-parts white epoxy-coated sheet-metal
- Built-In dimensions: W x D x H, 568 x 323 x 50 mm
- Packing dimensions: W x D x H, 580 x 335 x 60 mm
- Weight incl. packing 1,9 kg



Ironing-Board Unit

Passend für Schränke
Suitable for cabinets

60 cm

Ironing-Board Unit, pull-out, fold-down & rotating,
for minor laundry.
space required for fitting to wall-panel = 4 attachment holes' height

- Built-In dimensions: W x D x H, 562-578 x 466 x 153 mm
- Packing dimensions: W x D x H, 550 x 545 x 215 mm
- Weight incl. packing 15,5 kg



Swing



Für 60 cm breite Schränke.
For 60 cm wide cabinets.

Hailo Laundry Area

3271601

1

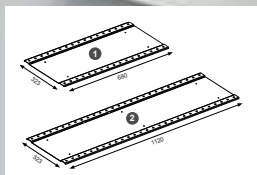

2

3271651

Wandpaneel klein/groß

Wandpaneel klein – 17 Löcher
zum Befestigen der Laundry Area Module

- Korrosionsfest beschichtetes Stahlblech, weiß
- Einbau-Maße: B x H, 323 x 680 mm
- Verpackungsmaße: B x T x H, 735 x 362 x 48 mm
- Gewicht mit Verpackung 5,1 kg
- Verpackungseinheit: 1 Paar

Wandpaneel groß – 28 Löcher
zum Befestigen der Laundry Area Module

- Korrosionsfest beschichtetes Stahlblech, weiß
- Einbau-Maße: B x H, 323 x 1120 mm
- Verpackungsmaße: B x T x H, 1190 x 362 x 48 mm
- Gewicht mit Verpackung 8,4 kg
- Verpackungseinheit: 1 Paar

Hailo Laundry Area

3271951

Stabilisierungswinkel

Stabilisierungswinkel für Korpus,
horizontale Verstärkung für höhere Schränke.

- Korrosionsfest beschichtetes Stahlblech, weiß
- Einbau-Maße: B x T x H, 562-572 x 20 x 42 mm
- Verpackungsmaße: B x T x H, 470 x 55 x 35 mm
- Gewicht mit Verpackung 0,5 kg

Hailo Laundry Area

3271901

Anbau Wäschetrockner

Anbau Wäschetrockner (zum Anbau außen am Schrank
oder an der Wand – klappbar)

- Korrosionsfest beschichtetes Stahlblech, weiß
- Einbau-Maße: B x T x H, 525 x 820 x 300 mm
- Verpackungsmaße: B x T x H, 740 x 545 x 200 mm
- Gewicht mit Verpackung 3,6 kg



Wall-Panel, small/large

Passend für Schränke
Suitable for cabinets

60 cm

Wall-Panel, small,

comes with 17 pairs of pre-drilled holes for fixing of the Laundry Area Modules, white epoxy-coated sheet-metal

- Built-In dimensions: W x H, 323 x 680 mm
- Packing dimensions: W x D x H, 735 x 362 x 48 mm
- Weight incl. packing 5,1 kg
- Packing unit: 1 pair



Wall-Panel, large,

comes with 28 pairs of pre-drilled holes for fixing of the Laundry Area Modules, white epoxy-coated sheet-metal

- Built-In dimensions: W x H, 323 x 1120 mm
- Packing dimensions: W x D x H, 1190 x 362 x 48 mm
- Weight incl. packing 8,4 kg
- Packing unit: 1 pair



Stabilizer-Bar

Passend für Schränke
Suitable for cabinets

60 cm

Stabilizer-Bar for carcass, adjustable horizontal reinforcement for taller cupboards. white epoxy-coated sheet-metal

- Built-In dimensions: W x D x H, 562-572 x 20 x 42 mm
- Packing dimensions: W x D x H, 470 x 55 x 35 mm
- Weight incl. packing 0,5 kg



Laundry-Rack

Passend für Schränke
Suitable for cabinets

60 cm

Laundry-Rack, externally wall-mounted, foldaway type, modified metal-parts white epoxy-coated sheet-metal and metal-bars

- Built-In dimensions: W x D x H, 525 x 820 x 300 mm
- Packing dimensions: W x D x H, 740 x 545 x 200 mm
- Weight incl. packing 3,6 kg





reddot award



PLUS X AWARDS
BESTES PRODUKT
DES JAHRES
2014

Übrigens, wussten Sie, ... dass Hailo Produkte bereits viele Auszeichnungen erhalten haben?

By the way, did you know... that Hailo products have already won many awards?

Hailo Laundry Carrier.

Hailo Laundry Carrier.



Slide



Für 45 cm, 50 cm oder 60 cm breite Unterschränke.
For 45 cm, 50 cm or 60 cm wide base-cabinets.

Hailo Laundry Carrier 450



3270451

SMOOTH
TEC



Der Hailo Laundry-Carrier bietet mit seinen 2 großvolumigen Systemkörben mit je 33 l Inhalt ausreichend Platz für 2 volle Waschmaschinenladungen.

- Wäschebehälter: 2 x 33 l
- Montageart: Seitenwandmontage, selbstjustierend 16 - 19 mm
- **Auszugsschiene: abgedeckter, gedämpfter Selbsteinzug mit Überauszug**
- Material, Farbe: Metallteile Stahlblech weiß, Kunststoffteile weiß/hellblau
- Produkt-Maße: B x T x H 412-418 x 528 x 545 mm
- Systemtiefe: 528 mm
- Verpackungsmaße: B x T x H 490 x 320 x 620 mm
- Gewicht mit Verpackung 12,4 kg

Hailo Laundry Carrier 500



3270501

SMOOTH
TEC



- Wäschebehälter: 2 x 33 l
- Montageart: Seitenwandmontage, selbstjustierend 16 - 19 mm. Inkl. 4 x 25 mm Distanzstücken
- **Auszugsschiene: abgedeckter, gedämpfter Selbsteinzug mit Überauszug**
- Material, Farbe: Metallteile Stahlblech weiß, Kunststoffteile weiß/hellblau
- Produkt-Maße: B x T x H 462-468 x 528 x 545 mm
- Systemtiefe: 528 mm
- Verpackungsmaße: B x T x H 490 x 320 x 620 mm
- Gewicht mit Verpackung 12,7 kg

Hailo Laundry Carrier 600



3270601

SMOOTH
TEC



- Wäschebehälter: 2 x 33 l, Zusatzbehälter 1 x 12 l, 1 x 2,5 l
- Montageart: Seitenwandmontage, selbstjustierend 16 - 19 mm
- **Auszugsschiene: abgedeckter, gedämpfter Selbsteinzug mit Überauszug**
- Material, Farbe: Metallteile Stahlblech weiß, Kunststoffteile weiß/hellblau
- Produkt-Maße: B x T x H 562-568 x 528 x 545 mm
- Systemtiefe: 528 mm
- Verpackungsmaße: B x T x H 590 x 325 x 620 mm
- Gewicht mit Verpackung 14,9 kg

The Hailo Laundry-Carrier with its 2 large volume laundry-baskets, of 33 l cpty. each, offers sufficient space for 2 washing-machine loads.



- Baskets capacity: 2 x 33 l
- Type of installation: Sidewall mounting, self-adjust. 16 to 19 mm
- **Slides: covered, dampened slides with self-closing device with over-travel**
- Material, colour: Metal parts sheet-steel white coated, Plastic parts white / light-blue
- Product dimensions: W x D x H 412-418 x 528 x 545 mm
- System-depth: 528 mm
- Packing dimensions: W x D x H 490 x 320 x 620 mm
- Weight incl. packing 12,4 kg

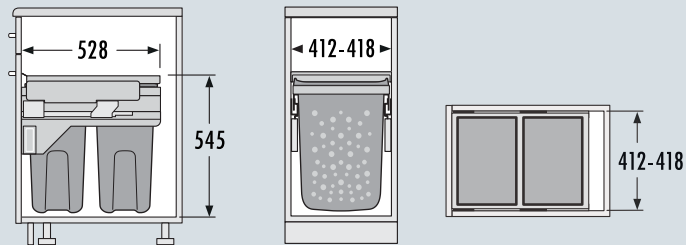

- Baskets capacity: 2 x 33 l
- Type of installation: Sidewall mounting, self-adjust. 16 to 19 mm, incl. 4 x 25 mm spacer-blocks
- **Slides: covered, dampened slides with self-closing device with over-travel**
- Material, colour: Metal parts sheet-steel white coated, Plastic parts white / light-blue
- Product dimensions: W x D x H 462-468 x 528 x 545 mm
- System-depth: 528 mm
- Packing dimensions: W x D x H 490 x 320 x 620 mm
- Weight incl. packing 12,7 kg

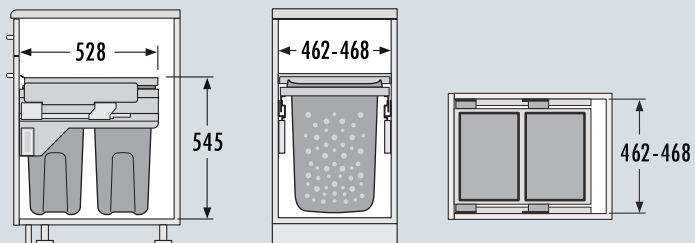

- Baskets capacity: 2 x 33 l
add. Bins 1 x 12 l, 1 x 2,5 l
- Type of installation: Sidewall mounting, self-adjust. 16 to 19 mm
- **Slides: covered, dampened slides with self-closing device with over-travel**
- Material, colour: Metal parts sheet-steel white coated, Plastic parts white / light-blue
- Product dimensions: W x D x H 562-568 x 528 x 545 mm
- System-depth: 528 mm
- Packing dimensions: W x D x H 590 x 325 x 620 mm
- Weight incl. packing 14,9 kg

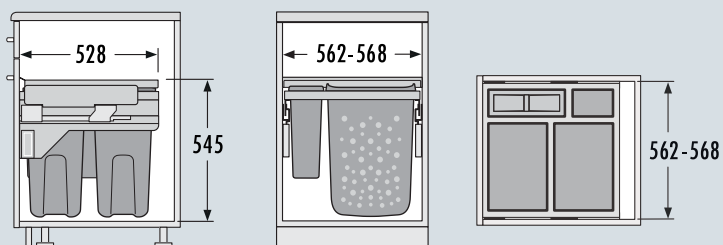

Slide



Für 60 cm breite Unterschränke.
For 60 cm wide base-cabinets.

Hailo Laundry Carrier S 600

3270691



- Wäschebehälter: 2 x 33 l
- Montageart: Seitenwandmontage, selbstjustierend 16 - 19 mm. Inkl. 4 x 25 mm Distanzstücken
- Auszugsschiene: **abgedeckter, gedämpfter Selbsteinzug mit Überauszug**
- Material, Farbe: Metallteile Stahlblech weiß, Kunststoffteile weiß/hellblau
- Produkt-Maße: B x T x H 562-568 x 448 x 545
- Systemtiefe: 448 mm
- Verpackungsmaße: B x T x H 590 x 325 x 620 mm
- Gewicht mit Verpackung 12,5 kg

- Baskets capacity: 2 x 33 l
- Type of installation: Sidewall mounting, self-adjust. 16 to 19 mm, incl. 4 x 25 mm spacer-blocks
- Slides: covered, dampened slides with self-closing device with over-travel
- Material, colour: Metal parts sheet-steel white coated, Plastic parts white / light-blue
- Product dimensions: W x D x H 562-568 x 448 x 545
- System-depth: 448 mm
- Packing dimensions: W x D x H 590 x 325 x 620 mm
- Weight incl. packing 12,5 kg

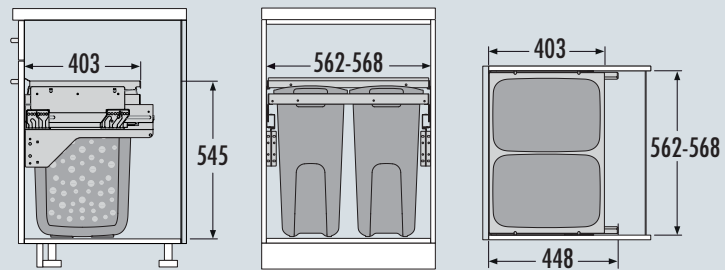

Swing



Für Schränke ab 40 cm Breite mit Drehtür
For 40 cm wide cabinets.

Hailo Wertstoff Depot

3272111



NEW

Hailo Wertstoff Depot

Das praktische Wertstoffdepot zum Einbau in Schränke oder außen an die Schrankwand. Trägermodul und große Deckelklappe aus stabilem, pulverbeschichtetem Stahlblech.

Einhängevorrichtung für Müllsäcke oder Stoffbeutel.

Einfache Montage mit nur 4 Schrauben.

- Inklusive stabilem Baumwollsack
- Produkt-Maße: B x T x H, 404 x 261 x 125 mm
- Verpackungsmaße: B x T x H, 420 x 280 x 145 mm
- Gewicht mit Verpackung: 2,3 kg



Hailo Collector

The handy metal frame with cotton-bag for fitting inside or out-side the cupboard.

Wall Bracket and large Lid made of sturdy powder-coated sheet-metal.

With attachment device for plastic bin-liners or cotton fabric-bags.

Easy installation with just 4 screws.

- comes with sturdy Cotton-Bag
- Product dimensions: W x D x H, 404 x 261 x 125 mm
- Packing dimensions: W x D x H, 420 x 280 x 145 mm
- Weight incl. packing 2,3 kg

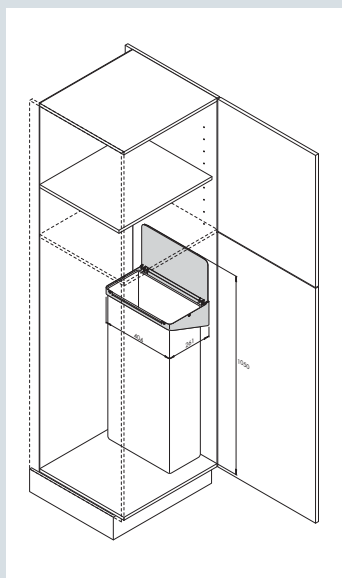

Übrigens, wussten Sie, ...

dass Hailo Produkte bereits viele Auszeichnungen erhalten haben?

By the way, did you know...

that Hailo products have already won many awards?



reddot award



Hailo Bad-Kosmetikeimer.

Hailo Bathroom-Bin.



Bad Kosmetikeimer

Für Unterschränke mit Drehtüre, Unterschränke mit vorhandenem Auszug oder zur Wandmontage.

3215251



Der Hailo Bad-Kosmetikeimer aus weißem stabilem Kunststoff wird in 3 Größen (Höhen) von 7, 8 und 10 Liter Inhalt jedem Bedarf als Bad Kosmetikeimer gerecht – für alles was diskret verschwinden soll.

- Abfalleimer 7 l Inhalt
- Produkt-Maße: B x T x H, 231 x 167 x 297 mm
- verdeckte Müllbeutel
- Verpackungsmaße: B x T x H, 241 x 184 x 365 mm
- Gewicht mit Verpackung 1,3 kg
- Kann links- wie rechtsseitig montiert werden

Bad Kosmetikeimer

3215291



Die schmale, hohe Form des Eimers eignet sich auch zur Aufnahme von Spraydosen und Shampooflaschen.

- Abfalleimer 8 l Inhalt
- Produkt-Maße B x T x H, 231 x 167 x 337 mm
- verdeckte Müllbeutel
- Verpackungsmaße: B x T x H, 241 x 184 x 365 mm
- Gewicht mit Verpackung 1,3 kg
- Kann links- wie rechtsseitig montiert werden

Bad Kosmetikeimer

3215351



Der praktische Schwingdeckel schließt automatisch nach jedem Einwurf.

- Abfalleimer 10 l Inhalt
- Produkt-Maße: B x T x H, 231 x 167 x 392 mm
- verdeckte Müllbeutel
- Verpackungsmaße: B x T x H, 247 x 196 x 430 mm
- Gewicht mit Verpackung 1,4 kg
- Kann links- wie rechtsseitig montiert werden

Bathroom-Bin For bathroom base-cabinets with hinged door, or with drawer, or for direct attachment onto wall-tiles.

The Hailo Bathroom-Bin, made from high-grade white plastic material, is available in 3 sizes, with 7 L, or 8 L, or 10 L capacity, and meets any requirement for a bathroom bin - for everything which needs to be disposed of.

- Bin capacity 7 l
- Product-dimensions: W x D x H, 231 x 167 x 297 mm
- hidden bin liner
- Packing dimensions: W x D x H, 241 x 184 x 365 mm
- Weight incl. packing 1,3 kg
- May be installed on left or on right sidewall

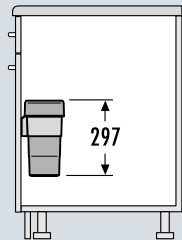

Bathroom-Bin

The small, tall shape of the bin is also suitable for disposal of spray cans and shampoo bottles.

- Bin capacity 8 l
- Product-dimensions: W x D x H, 231 x 167 x 337 mm
- hidden bin liner
- Packing dimensions: W x D x H, 241 x 184 x 365 mm
- Weight incl. packing 1,3 kg
- May be installed on left or on right sidewall

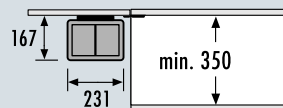
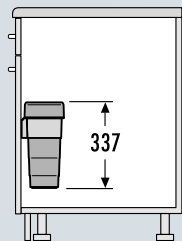

Bathroom-Bin

The practical, automatically closing flaps are a real odour-trap.

- Bin capacity 10 l
- Product-dimensions: W x D x H, 231 x 167 x 392 mm
- hidden bin liner
- Packing dimensions: W x D x H, 247 x 196 x 430 mm
- Weight incl. packing 1,4 kg
- May be installed on left or on right sidewall

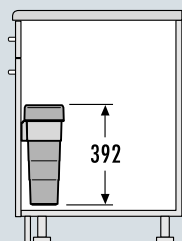

Eimer, Einsätze, Zubehör

Bins, Inserts, Accessoires



**Inneneimer
Inner Bins**



Seite/ Page 243 - 261

**Hailo On Top Behälter
Hailo On Top Container**



Seite/ Page 263 - 265

**Schlauchbrausenabweiser
Wall-Bracket for Flex-Hose**



Seite/ Page 264 - 265

Kitty



Seite/ Page 266 - 267

Bathroom Kitty



Seite/ Page 266 - 267

Übrigens, wussten Sie, ...

By the way, did you know...

dass Hailo die größte Eimervielfalt für jeden Bedarf vorhält?

that Hailo provides the widest range of bins for all requirements?



Hailo Inneneimer

Hailo Inner Bins



Hailo Inneneimer

Hailo Inner Bins



Hailo Inneneimer

Hailo Inner Bins



Art. Nr. Deckel/lid		1107279	1100719	1068589
Art. Nr. Eimer/bin	1102429	1107289	1073979	1102439
Volumen ca./ Volume aprox.	2,5 Liter	6,5 Liter	14 Liter	7 Liter
Breite/Tiefe / Width/Depth	B x T / W x D	B x T / W x D	B x T / W x D	B x T / W x D
Eimerhöhe/bin height 220 mm	155 x 110	226 x 174	350 x 226	
Eimerhöhe/bin height 255 mm				226 x 156
Eimerhöhe/bin height 295 mm				
Müllbeutel/trashbag				

Müllbeutel

Trash-Bags



Wir bieten passgenaue Müllbeutel in 7 verschiedenen Größen für die jeweiligen Inneneimer an. Die Piktogramme für den jeweils passenden Müllbeutel sind in der Inneneimerübersicht sowie bei Produkten mit entsprechendem Inneneimer zu finden.

We offer custom-fit trash bags in 7 different sizes for the corresponding inner bins. The icon for the appropriate trash bag can be found in the inner bin list as well as with products with corresponding inner bin.



Art. Nr. 0010001



Art. Nr. 0020181



Art. Nr. 0040001



Art. Nr. 0013081



Art. Nr. 0018081



Art. Nr. 0028081



Art. Nr. 0055081



1104849

1068589

1107249

1104849

1102459

1075959

1102449

1093479

15 Liter

8 Liter

12 Liter

18 Liter

B x T / W x D

B x T / W x D

B x T / W x D

B x T / W x D

320 x 226

226 x 156

320 x 156

320 x 226



Hailo Inneneimer

Hailo Inner Bins



10 Ltr.



12 Ltr.



14 Ltr.



15 Ltr.



20 Ltr.



24 Ltr.



21 Ltr.





28 Ltr.

Hailo Inneneimer

Hailo Inner Bins



Art. Nr. Deckel/lid	1068589	1125089	1107249	1107269
Art. Nr. Eimer/bin	1075969	1122459	1075989	1076099
Volumen ca./ Volume aprox.	10 Liter	12 Liter	14 Liter	15 Liter
Breite/Tiefe / Width/Depth	B x T / W x D	B x T / W x D	B x T / W x D	B x T / W x D
Eimerhöhe/bin height 350 mm	226 x 156	320 x 141	320 x 156	226 x 233
Müllbeutel/trashbag				

Müllbeutel

Trash-Bags



Wir bieten passgenaue Müllbeutel in 7 verschiedenen Größen für die jeweiligen Inneneimer an. Die Piktogramme für den jeweils passenden Müllbeutel sind in der Inneneimerübersicht sowie bei Produkten mit entsprechendem Inneneimer zu finden.

We offer custom-fit trash bags in 7 different sizes for the corresponding inner bins. The icon for the appropriate trash bag can be found in the inner bin list as well as with products with corresponding inner bin.



Art. Nr. 0010001



Art. Nr. 0020181



Art. Nr. 0040001



Art. Nr. 0013081



Art. Nr. 0018081



Art. Nr. 0028081



Art. Nr. 0055081



1104849

1100719

x

x

1076119

1076129

1129679

1125729

20 Liter

24 Liter

21 Liter

28 Liter

B x T / W x D

B x T / W x D

B x T / W x D

B x T / W x D

320 x 226

350 x 226

192 x 415

224 x 415



Hailo Inneneimer



Hailo Inner Bins



Hailo Inneneimer

Hailo Inner Bins



Art. Nr. Deckel/lid	1132949	x	x	
Art. Nr. Eimer/bin	1132959	1132969	1132979	
Volumen ca./ Volume aprox.	13 Liter	18 Liter	28 Liter	
Breite/Tiefe / Width/Depth	B x T / W x D	B x T / W x D	B x T / W x D	
Eimerhöhe/bin height 380 mm	242 x 192	385 x 166	385 x 242	
Eimerhöhe/bin height 413 mm				
Müllbeutel/trashbag				

Müllbeutel

Trash-Bags



Wir bieten passgenaue Müllbeutel in 7 verschiedenen Größen für die jeweiligen Inneneimer an. Die Piktogramme für den jeweils passenden Müllbeutel sind in der Inneneimerübersicht sowie bei Produkten mit entsprechendem Inneneimer zu finden.

We offer custom-fit trash bags in 7 different sizes for the corresponding inner bins. The icon for the appropriate trash bag can be found in the inner bin list as well as with products with corresponding inner bin.



Art. Nr. 0010001



Art. Nr. 0020181



Art. Nr. 0040001



Art. Nr. 0013081



Art. Nr. 0018081



Art. Nr. 0028081



Art. Nr. 0055081



1107239

x

1069559

1107229

1071319

1058089

13 Liter

19 Liter

30 Liter

B x T / W x D

B x T / W x D

B x T / W x D

258 x 198

397 x 171

397 x 258



Hailo Inneneimer



Hailo Inner Bins



Hailo Inneneimer

Hailo Inner Bins



Art. Nr. Deckel/lid	1100719	x	x	
Art. Nr. Eimer/bin	1100709	1080369	1132989	
Volumen ca./ Volume aprox.	29 Liter	42 Liter	55 Liter	
Breite/Tiefe / Width/Depth	B x T / W x D	B x T / W x D	B x T / W x D	
Eimerhöhe/bin height 485 mm	350 x 226			
Eimerhöhe/bin height 500 mm		415 x 285	385 x 358	
Eimerhöhe/bin height 522 mm				
Eimerhöhe/bin height 525 mm				
Müllbeutel/trashbag				

Müllbeutel

Trash-Bags



Wir bieten passgenaue Müllbeutel in 7 verschiedenen Größen für die jeweiligen Inneneimer an. Die Piktogramme für den jeweils passenden Müllbeutel sind in der Inneneimerübersicht sowie bei Produkten mit entsprechendem Inneneimer zu finden.

We offer custom-fit trash bags in 7 different sizes for the corresponding inner bins. The icon for the appropriate trash bag can be found in the inner bin list as well as with products with corresponding inner bin.



Art. Nr. 0010001



Art. Nr. 0020181



Art. Nr. 0040001



Art. Nr. 0013081



Art. Nr. 0018081



Art. Nr. 0028081



Art. Nr. 0055081



1128339

1014169

38 Liter

B x T / W x D

378 x 261



1100719

1130439

32 Liter

B x T / W x D

350 x 226















Hailo Inneneimer

Hailo Inner Bins

Breite/Width	155 mm	226 mm	226 mm	233 mm	242 mm	258 mm	320 mm	320 mm	320 mm	350 mm
Tiefe/Depth	110 mm	156 mm	174 mm	226 mm	192 mm	198 mm	141 mm	156 mm	226 mm	226 mm
	Art. Nr.	Art. Nr.	Art. Nr.	Art. Nr.	Art. Nr.	Art. Nr.	Art. Nr.	Art. Nr.	Art. Nr.	Art. Nr.
Eimerhöhe bin height 220 mm	 2,5l 1102429*		 6,5l 1107279							 14l 1073979
255 mm		 7l 1102439							 15l 1102459	
295 mm		 8l 1075959					 12l 1102449	 18l 1093479		
350 mm		 10l 1075969		 15l 1076099			 12l 1122459	 14l 1075989	 20l 1076119	 24l 1076129
380 mm					 13l 1132959					
413 mm						 13l 1107239**				
485 mm										 29l 1100709
500 mm										
522 mm										
525 mm										 32l 1130439

* ohne Bügel / without handels

** ohne Bügel, mit integrierten geformten Griffen / without handels, with integrated moulded grip

378 mm 261 mm Art. Nr.	380 mm 252 mm Art. Nr.	385 mm 166 mm Art. Nr.	385 mm 242mm Art. Nr.	385 mm 358 mm Art. Nr.	397 mm 171 mm Art. Nr.	397 mm 258 mm Art. Nr.	415 mm 192 mm Art. Nr.	415 mm 224 mm Art. Nr.	415 mm 285 mm Art. Nr.
							 21l 1129679	 28l 1125729	
		 18l 1132969	 28l 1132979						
					 19l 1071319	 30l 1058089			
				 55l 1132989				 42l 1080369	
 38l 1014169	 33l 1126889								

** ohne Bügel, mit integrierten geformten Griffen / without handles, with integrated moulded grip

Hailo Inneneimer

Hailo Inner Bins



Hailo Inneneimer

Hailo Inner Bins



Art. Nr. Deckel/lid	1017519	1017519	1017519	1069619	1082739
Art. Nr. Eimer/bin	1049519	1086239	1094079	1049479	1094089
Volumen ca./ Volume aprox.	18 Liter	18 Liter	18 Liter	12 Liter	8,5 Liter
Breite/Tiefe / Width/Depth	B x T / W x D	B x T / W x D	B x T / W x D	B x T / W x D	B x T / W x D
Eimerhöhe/bin height 295 mm	316 x 226	316 x 226	316 x 226	316 x 154	226 x 150
Eimerhöhe/bin height 325 mm					
Eimerhöhe/bin height 350 mm					
Müllbeutel/trashbag					

Müllbeutel

Trash-Bags

Wir bieten passgenaue Müllbeutel in 3 verschiedenen Größen für die jeweiligen Inneneimer an.
Die Größen S, M und L sind in der Inneneimerübersicht sowie bei Produkten mit entsprechendem Inneneimer zu finden.

We offer custom-fit trash bags in 3 different sizes for the corresponding inner bins.
The sizes S, M and L can be found in the inner bin list as well as with products with corresponding inner bin.



Art. Nr. 0010001



Art. Nr. 0020181



Art. Nr. 0040001



1082739

1049529

8,5 Liter

B x T / W x D

226 x 150



1082489

20 Liter

B x T / W x D

310 x 225



1082609

20 Liter

B x T / W x D

310 x 225



1082599

20 Liter

B x T / W x D

310 x 225



1045639

10 Liter

B x T / W x D

226 x 154



1045629

10 Liter

B x T / W x D

226 x 154



Hailo Inneneimer





Hailo Inner Bins



Hailo Inneneimer

Hailo Inner Bins



Art. Nr. Deckel/lid				
Art. Nr. Eimer/bin	1082479	1082419	1080989	1080999
Volumen ca./ Volume aprox.	7 Liter	7 Liter	7 Liter	7 Liter
Breite/Tiefe / Width/Depth	B x T / W x D	B x T / W x D	B x T / W x D	B x T / W x D
Eimerhöhe/bin height 350 mm	226 x 115	226 x 115	226 x 115	226 x 115
Müllbeutel/trashbag				

Müllbeutel

Trash-Bags

Wir bieten passgenaue Müllbeutel in 3 verschiedenen Größen für die jeweiligen Inneneimer an.
Die Größen S, M und L sind in der Inneneimerübersicht sowie bei Produkten mit entsprechendem Inneneimer zu finden.

We offer custom-fit trash bags in 3 different sizes for the corresponding inner bins.
The sizes S, M and L can be found in the inner bin list as well as with products with corresponding inner bin.



Art. Nr. 0010001



Art. Nr. 0020181



Art. Nr. 0040001



1050209	1045129	1008879	1045119	1073259	1073269
24 Liter	24 Liter	15 Liter	15 Liter	15 Liter	15 Liter
B x T / W x D	B x T / W x D	B x T / W x D	B x T / W x D	B x T / W x D	B x T / W x D
345 x 220	345 x 220	230 x 220	230 x 220	230 x 220	230 x 220

Hailo Inneneimer

Hailo Inner Bins



Hailo Inneneimer

Hailo Inner Bins



Art. Nr. Eimer/bin	1082119	1082399	1081529	1081699
Volumen ca./ Volume aprox.	18 Liter	8 Liter	12 Liter	15 Liter
Breite/Tiefe / Width/Depth	B x T / W x D	B x T / W x D	Ø	Ø
Eimerhöhe/bin height 365 mm	343 x 185			
Eimerhöhe/bin height 367 mm		187 x 171		
Eimer/bin Ø 270 mm			270	
Eimer/bin Ø 275 mm				270
Müllbeutel/trashbag				

Müllbeutel

Trash-Bags

Wir bieten passgenaue Müllbeutel in 3 verschiedenen Größen für die jeweiligen Inneneimer an.
Die Größen S, M und L sind in der Inneneimerübersicht sowie bei Produkten mit entsprechendem Inneneimer zu finden.

We offer custom-fit trash bags in 3 different sizes for the corresponding inner bins.
The sizes S, M and L can be found in the inner bin list as well as with products with corresponding inner bin.



Art. Nr. 0010001



Art. Nr. 0020181



Art. Nr. 0040001



1082629

15 Liter

∅

275











1030459









20 Liter

∅

275



Breite/Width	187 mm	226 mm	226 mm	226 mm	230 mm
Tiefe/Depth	171 mm	115 mm	150 mm	154 mm	220 mm
	Art. Nr.	Art. Nr.	Art. Nr.	Art. Nr.	Art. Nr.
Eimerhöhe bin height 253 mm					
295 mm			 <p>1082739</p> <p>8,5l </p> <p>1094089 hellgrau/light-grey 1049529 dunkelgrau/dark-grey</p>		
299 mm					
324 mm					
325 mm					
350 mm		 <p>7l </p> <p>1082479 grau/grey 1082419 weiß/white 1080989 grün/green 1080999 braun/brown</p>		 <p>10l </p> <p>1045639 grau/grey 1045629 weiß/white</p>	 <p>15l </p> <p>1008879 grau/grey 1045119 weiß/white 1073259 grün/green 1073269 braun/brown</p>
365 mm					
367 mm	 <p>8l</p> <p>1082399</p>				
413 mm					

310 mm	316 mm	316 mm	342 mm	345 mm	∅	∅
225 mm	154 mm	226 mm	181 mm	220 mm	270 mm	275 mm
Art. Nr.	Art. Nr.	Art. Nr.	Art. Nr.	Art. Nr.	Art. Nr.	Art. Nr.
					 12l 1081529	
	 12l 1069619 1049479	 18l 1017519 1094079 hellgrau/light-grey 1049519 dunkelgrau/dark-grey 1086239 schwarz/black				
						 15l 1082629
					 15l 1081699	
 20l 1082609 grau/grey 1082489 weiß/white 1082599 braun/brown						
				 24l 1050209 grau/grey 1045129 weiß/white		
			 18l 1082119			
						 20l 1030459



Übrigens, wussten Sie, ...

dass die Marke Hailo in Deutschland einen Bekanntheitsgrad von etwa 53% besitzt?

By the way, did you know...

that the Hailo brand enjoys a recognition factor of approx. 53% in Germany?

Hailo Zubehör-, Ordnungs- und Funktionseinsätze

Hailo Accessories, Organizer- & Functional-Inserts

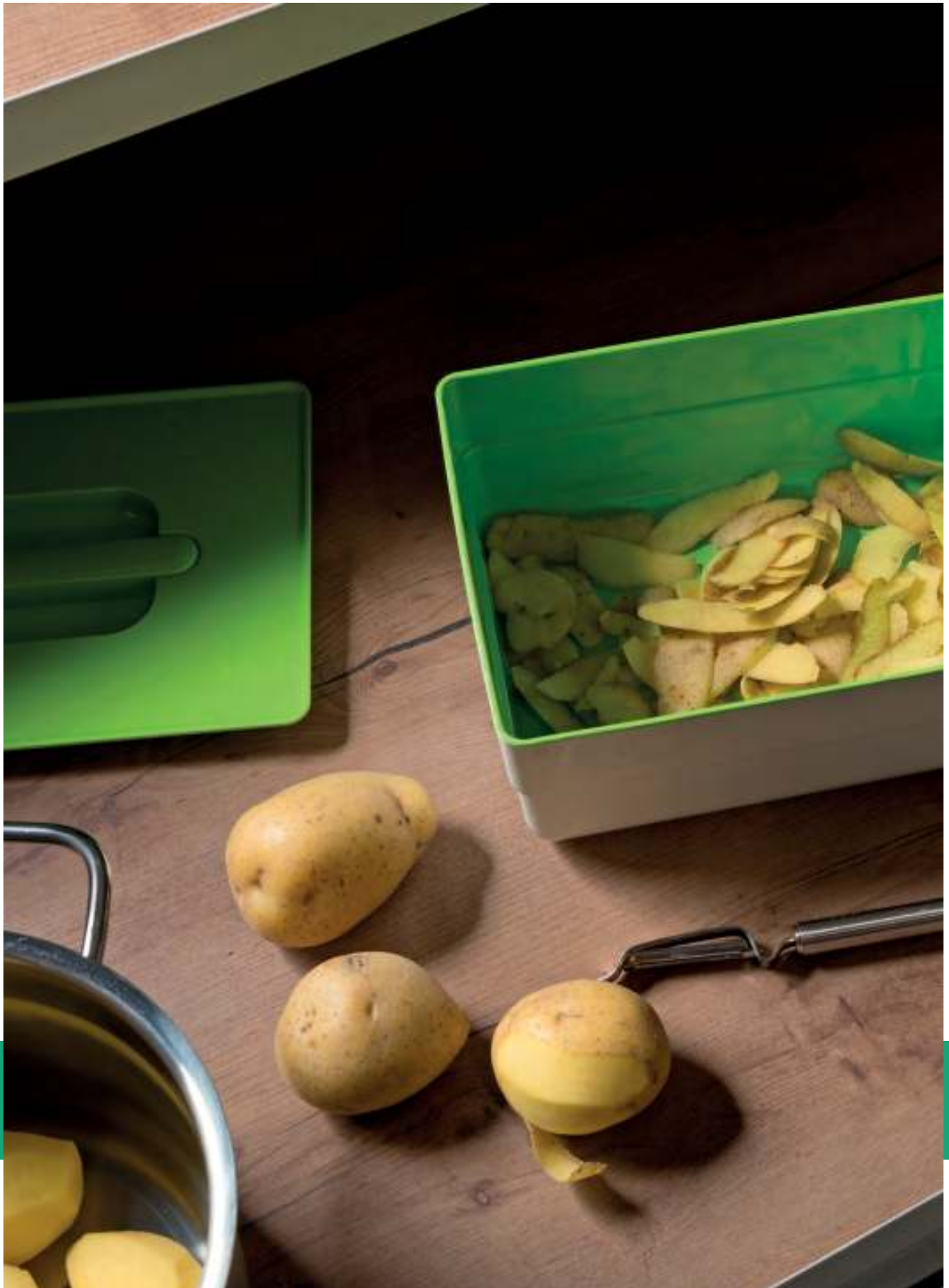

Zubehör-, Ordnungs- und Funktionseinsätze für Auszugssysteme von Hailo Accessories, Organizer- & Functional-Inserts for Hailo recycling-systems.

Hailo On Top Behälter

3205101



- Behälter: 1 x 4 l, hellgrün/weiß
1 x Behälterdeckel 4 l
- Produkt-Maße
B x T x H, 230 x 180 x 107 mm
- Verpackungsmaße: B x T x H, 247 x 190 x 121 mm
- Gewicht mit Verpackung 0,7 kg

Schlauchbrausenabweiser

3693001



Metallbügel zum Einbau in Spülenunterschranke zur gezielten Schlauchführung.

- Verpackungseinheit: 5

Hailo On Top Container

- Container: 1 x 4 l, light green/white, 1 x Lid 4 l
- Product Dimensions:
W x D x H, 230 x 180 x 107 mm
- Packing dimensions: W x D x H, 247 x 190 x 121 mm
- Weight incl. packing 0,7 kg

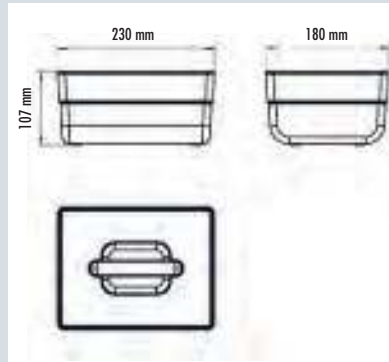

Wall-Bracket for Flex-Hose

Wire bracket for sink-cabinets,
for rerouting of flexible hoses.

- **Packing unit: 5 each per carton**



Zubehör-, Ordnungs- und Funktionseinsätze für Auszugssysteme von Hailo Accessories, Organizer- & Functional-Inserts for Hailo recycling-systems.

Hailo Kitty

3204101



Der neue Helfer in Küche und Haushalt

Hailo Kitty ist die vielseitig verwendbare Küchenhilfe – und viel, viel mehr. Funktionell und attraktiv im Design. Als Vorratsbehälter, Kompostsammler oder Utensilien-depot, im Spülensaugzug oder auf der Arbeitsplatte – der Behälter mit tausend Möglichkeiten.

Durch die kompakten Maße eignet sich Hailo Kitty exakt für den Einsatz im Spülensaugzug. Lebensmittelecht, Spülmaschinenfest.



- Inhalt: 4 l
- Kunststoffbehälter: dunkelgrau
- Deckel+Griff: hellgrau
- Produktmaße: B x T x H, 250 x 160 x 170 mm
- Verpackungsmaße: B x T x H, 265 x 175 x 180 mm
- Gewicht: 0,86 kg



Bathroom Kitty

3204901



- Inhalt: 4 l
- Kunststoffbehälter: weiß
- Deckel+Griff: weiß
- Produktmaße: B x T x H, 250 x 160 x 170 mm
- Verpackungsmaße: B x T x H, 265 x 175 x 180 mm
- Gewicht: 0,86 kg

The new assistant in the kitchen and the home

Kitty is a universally applicable kitchen aid - and much, much more. Functional and attractively designed.

Suitable as a storage container, compost collector or utensil box in the sink storage drawer or on the work top - a container with a thousand possibilities.

Capacity: 4 l

Thanks to compact dimensions, the Hailo Kitty may exactly be inserted in the sink pull-out.

Food-safe, Dishwasher-proof.

- Capacity: 4 l
- Plastic Body: dark-grey
- Lid+Handle: light-grey
- Product-dimensions: : W x D x H, 250 x 160 x 170 mm
- Packing dimensions: W x D x H, 265 x 175 x 180 mm
- Weight: 0,86 kg



- Capacity: 4 l
- Plastic Body: white
- Lid+Handle: white
- Product-dimensions: : W x D x H, 250 x 160 x 170 mm
- Packing dimensions: W x D x H, 265 x 175 x 180 mm
- Weight: 0,86 kg



Mehr von Hailo Einbautechnik.

More from Hailo Built-In Technology.

Kundenspezifische Lösungen

Customized Solutions

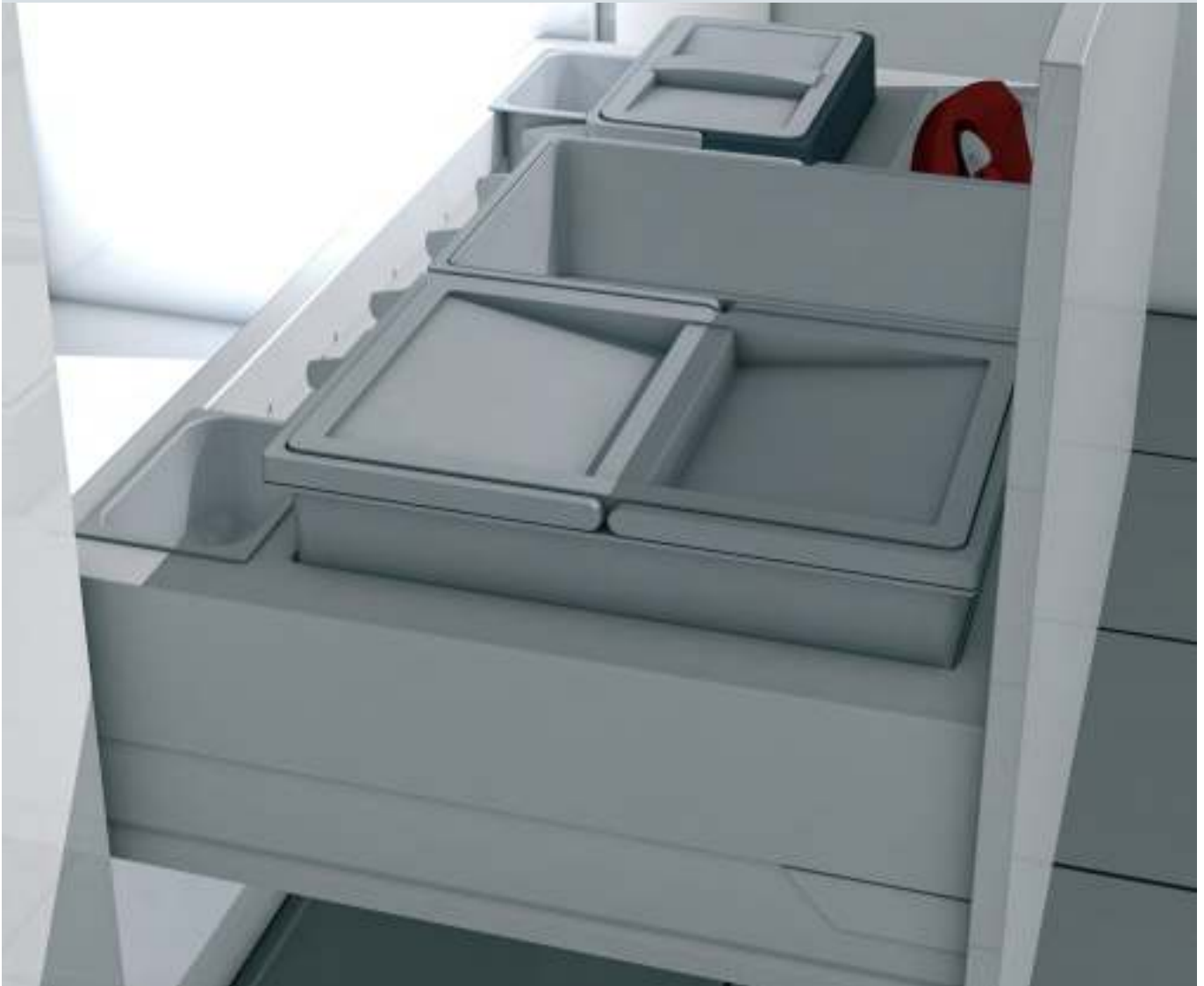

Neben dem umfangreichen Sortiment an Abfalltrenn- und Ordnungssystemen aus dem Standard Programm, bietet Hailo maßgeschneiderte, kundenspezifische Lösungen, die ihre Küchenmarke darin unterstützen einmalige Attribute aufzuweisen. Passgenaue Entwicklungen auf alle vorhandenen Auszüge und Schubkastensysteme namhafter Hersteller wie Blum, Grass, Hettich und weitere bieten Individualität und ein hohes Maß an Differenzierung.

Diesen Mehrwert in der Raumausnutzung und Gestaltung der Auszüge und Schubkästen entwickelt Hailo gemeinsam mit Ihnen und für Sie. Als Marktführer im Bereich Einbauten in Küchenschränke und Schubkästen finden wir auch für Sie passende Möglichkeiten. Viele namhafte Küchenhersteller vermarkten bereits erfolgreich ihre Küchen mit maßgefertigten Einbau-Systemen von Hailo.

As well as the extensive choice of waste separation and storage systems in its standard range, Hailo offers made-to-measure, customised solutions that support kitchen brands with their unique features. Precision-fit developments for all existing drawer systems and storage units supplied by well-known manufacturers, such as Blum, Grass, Hettich and others, lend individuality and provide for a high degree of differentiation.

Hailo develops this added value in the utilisation of space and the design of the drawer systems and storage units with you and for you. As the market leader in the kitchen cupboard and drawer storage fittings sector, we'll find the right options for you, too. Many well-known kitchen manufacturers already successfully market their kitchens with customized recycling systems.

Kundenspezifische Lösungen für Zargen (hängende Systeme) Customized solutions for Drawers (hang-thru bin systems)

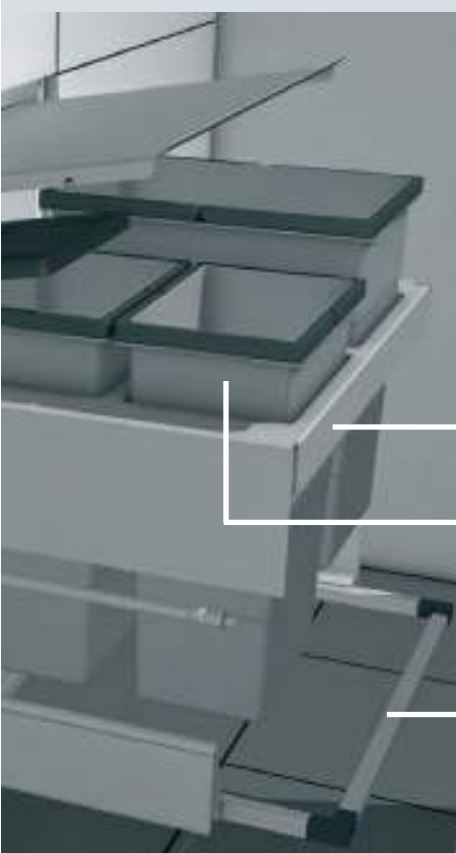
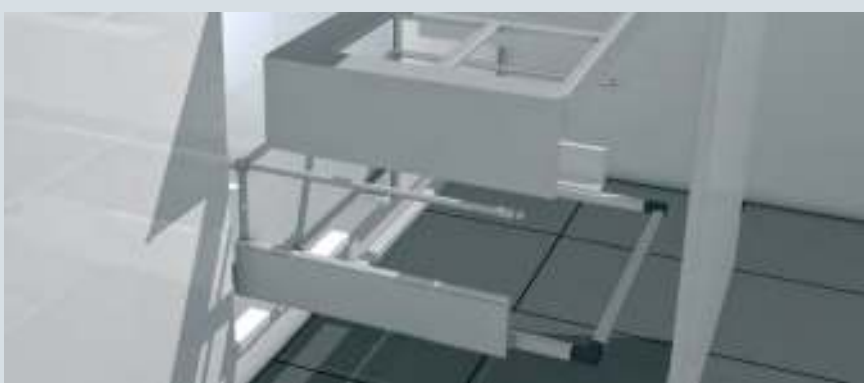

Zargen Cargo	Drawer Cargo
 <p>Passend auf alle handelsüblichen Zargen entwickelt Hailo ein patentiertes Abfalltrennsystem, das gleich mehrere Vorteile aufweist:</p> <ul style="list-style-type: none"> • Einfache Montage • Unveränderte Frontanbindung • Stabilität • Hygiene • Individualität • Vielseitigkeit <p>Konfigurieren Sie sich die Einsätze für ihr System selbst. Wählen Sie ihre individuelle Systembestückung aus einer Vielzahl von Eimern und Einsätzen (siehe Seiten 243-253).</p> <p>Beispiel einer Kundenlösung auf 60er Zarge</p>	<p>Suitable for all standard drawer frames, Hailo can develop a patented waste separation system for you that provides several benefits:</p> <ul style="list-style-type: none"> • Easy Installation • Front-Attachment and -Adjustment as usual • Stability • Hygiene • Individuality • Variability <p>Configuration of Bins and Inserts as per your requirement, and available space. (Pages 243-253)</p> <p>Example of a customized solution on a 60-drawer frame</p>

	 <ul style="list-style-type: none"> • Tragendes System. Behälter hängen frei in der Eimeraufnahme. Schubkastenboden nicht nötig. • Individuelle Eimerbestückung. Große Vielfalt an Varianten und Eimerkombinationen wählbar. • Geschlossenes System. Glatte, reinigungsfreundliche Flächen. Fehleinwurf wird vermieden. • Stabilisierungsrahmen als Ersatz für den Schubkastenboden. Zarge sitzt höher als bei normalem Auszug - dadurch erhöhte Stabilität. • Einstellbarkeit des Auszugs Herkömmliche Einstellbarkeit der Front bleibt erhalten. Es werden keine weiteren Befestigungswinkel benötigt. • Passende Systeme für alle Zargen. Egal welcher Hersteller, egal welche Breite oder Tiefe. • Einfache Montage, bewährte Frontanbindung. 	<ul style="list-style-type: none"> • Upper Bins Frame, hang - thru bins, without drawer bottom. • Individual bin configuration, as per cabinet-maker's requirements. • Closed system, flush sides & surfaces. • Stabilizer frame, Alu, replaces drawer-bottom. • Adjustment of front-panel and attachment in the usual way. Not any extra brackets needed. • Suitable systems for all common drawers, of any make, of any width, or depth. • Easy installation, usual front-adjustment.
---	---	---

Kundenspezifische Lösungen für Schubkästen (stehende Systeme) Customized solutions for common drawers (standing bins systems)

Hailo Separato

Hailo Separato



Für alle Schubladen und Schubkästen ab 2-Raster Höhe bietet Hailo mit dem Separato-System individuelle Gestaltungsmöglichkeiten.

Neu entwickeltes Hailo-System, patentiert, das gleich mehrere Vorteile aufweist:

- Einfache Montage
- Unveränderte Frontanbindung
- Stabilität
- Hygiene
- Individualität
- Vielseitigkeit
- Optimierter Installationsraum

For all drawers from 2 levels height, Hailo offers individual designs & solutions. Newly developed Hailo-system, patented, with various advantages:

- Easy Installation
- Usual Front - Adjustment and Attachment
- Stability
- Hygiene
- Individuality
- Flexibility
- Optimized Installation Area

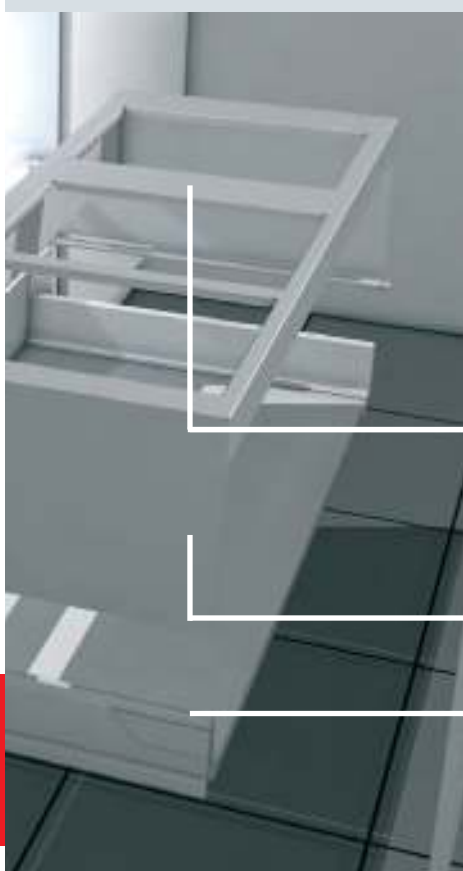

- **Individuelle Bestückung**
Eimer mit Ordnungs- und Reinigungssystemen. Abfallbehälter, Universalbehälter, Kehrsetz uvm.
- **Optimale Stauraumnutzung**
Abfalltrennung, Ordnungsutensilien übersichtlich, griffbereit zur Hand.
- **Geschlossenes System der Eimeraufnahme**
Fehleinwurf wird verhindert. Glatte Reinigungsflächen.
- **Einstellbarkeit des Auszugs**
Herkömmliche Einstellbarkeit der Front bleibt erhalten. Es werden keine weiteren Befestigungswinkel benötigt.
- **Einfache Montage,**
bewährte Frontanbindung.

- **Individual Configuration**
Bins, organizer, and cleansers-inserts.
- **Optimized utilisation of space.**
Recycling- and Organizer-Center
- **Closed upper frame flush surfaces.**
No miss-hits. No mess. Smooth surfaces for cleaning.
- **Usual Attachment and Adjustment of front-panel.**
No any further brackets required.
- **Easy Installation** - usual front attachment

Speziallösungen für den Großraum-Sockelauszug Special solutions for high-capacity Plinth Drawers



Hailo Sockel Cargo

Plinth Drawer Cargo

Optimale Raumausnutzung und ideale Ausgestaltung des Sockelschubkastens. Inkl. Nutzung des Sockelraumes.

- **Optimale Stauraumnutzung**
inkl. Nutzung des Sockelraumes.
- **Geschlossenes System der Eimeraufnahme**
Fehleinwurf wird verhindert.
Glatte Reinigungsflächen.
- **Einstellbarkeit des Auszugs**
wird durch das System nicht beeinträchtigt.
- **Einfache Montage,**
bewährte Frontanbindung.



Optimized utilisation of available space, and ideal use of plinth-drawer, including use of plinth-area.

- **Makes the best use of storage space**
Also utilises space behind plinth for storage.
- **Closed bins frame, flush surfaces,**
easy to clean. No miss-hits.
No mess. Smooth surfaces for cleaning.
- **Adjustment of pull-out**
is still be maintained.
- **Easy Installation,**
usual front-attachment



Platz für Ihre Notizen:

Space for your notes:

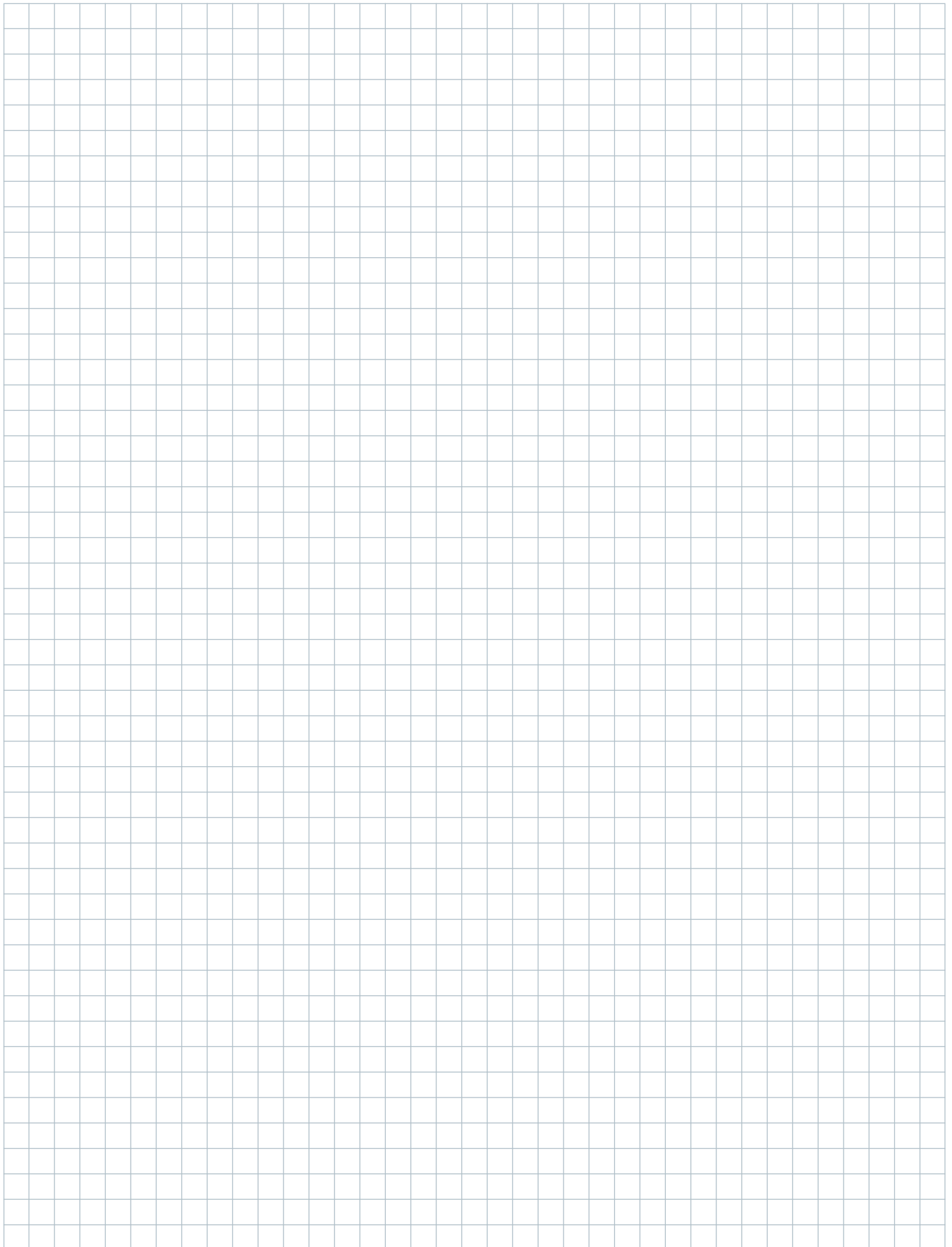

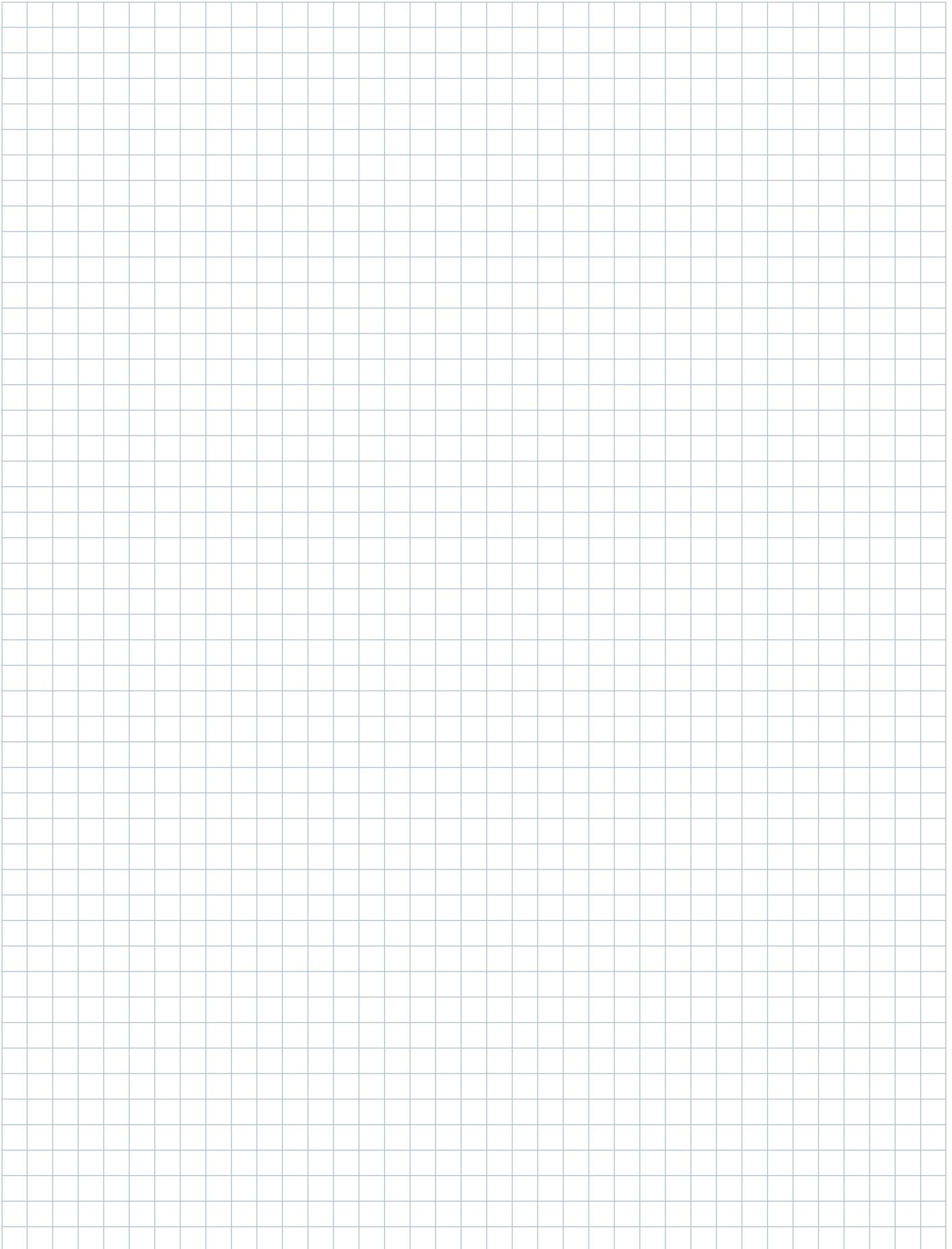

Platz für Ihre Notizen:

Space for your notes:

